



REXITE

objektiv GmbH & Co. KG
Büro- & Objektausstattung
Bunsenstr. 20
71032 Böblingen

Tel.: 07031/74 24 16-0
Fax.: 07031/74 24 16-1
URL: www.objektiv-gmbh.de
E-Mail: post@objektiv-gmbh.de



CATALOGO

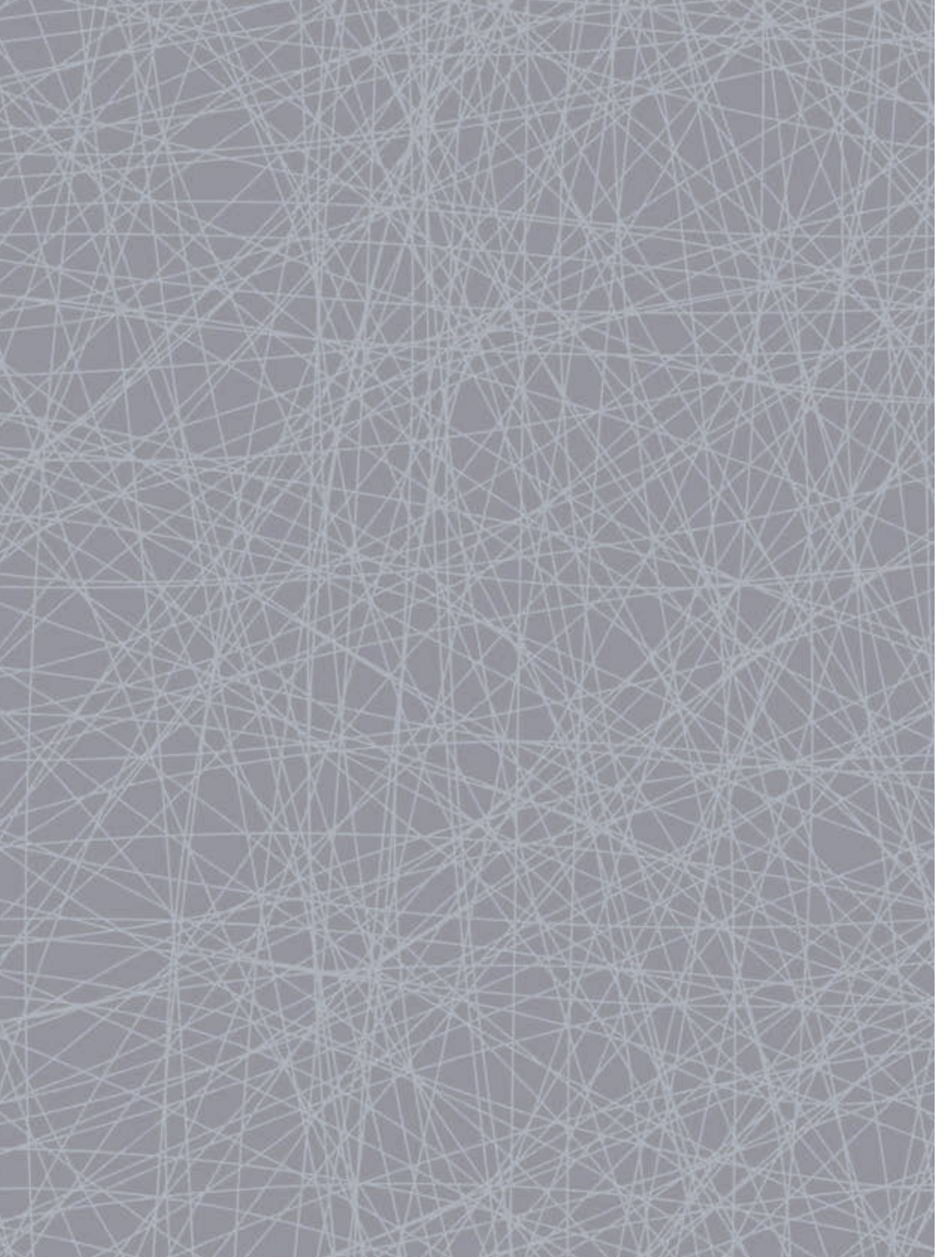

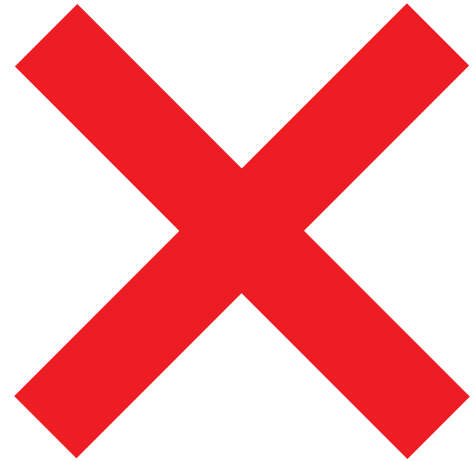

Semplice ma non banale, originale ma non bizzarro

Una filosofia ispiratrice mantenuta con coerenza attraverso gli anni, che ha consentito la creazione di prodotti dimostratisi degli autentici classici senza tempo, anche se fedeli interpreti della continua evoluzione della realtà e delle nuove tendenze. Le collezioni Rexite, destinate ai più svariati ambiti del mondo della Casa, dell'Ufficio e del Contract, si distinguono per il design rigoroso, l'alta qualità dei materiali e le tecnologie rispettose dell'ambiente.

Simple yet not ordinary, original but not bizarre

Constantly evolving timeless classics able to interpret reality and new trends: the output of an inspiring philosophy which has kept coherent over the years. Rexite collections, created for the most diverse Home, Office and Contract contexts, stand out thanks to rigorous design, high quality materials and eco-friendly technology.

Simple mais pas banal, original mais pas bizarre

Une philosophie inspiratrice conservée avec cohérence le long des années, qu'elle a permis de créer des produits qui se sont avérés des authentiques classiques sans temps, tout en restant de fidèles interprètes de l'évolution continue de la réalité et des nouvelles tendances. Les collections Rexite, destinées aux domaines les plus variés de la Maison, du Bureau et du Contract, ressortent pour le dessin rigoureux, la haute qualité des matières et des technologies vouées au respect de l'environnement.

Schlicht jedoch nicht banal, originell jedoch nicht bizarr

Eine anregende Philosophie, die mit Konsequenz im Laufe der Jahre beibehalten wurde, gab die Möglichkeit Produkte zu schaffen, die sich mit der Zeit authentisch und klassisch bewiesen haben, obwohl sie der ständigen Evolution der Realität und der neuen Tendenzen folgen. Die Rexite Kollektionen, die für die unterschiedlichen Bereiche der Wohnung, des Büros und des Contract bestimmt sind, zeichnen sich durch ihr präzises Design, durch die hohe Qualität der eingesetzten Materialien und der umweltfreundlichen Technologie aus.

Simple pero no banal, original pero no extravagante

Una filosofía inspiradora mantenida con coherencia a lo largo de los años, que ha permitido crear productos que han demostrado ser clásicos sin tiempo, aunque fieles intérpretes de la continua evolución de la realidad y de las nuevas tendencias. Las colecciones Rexite, destinadas a los ámbitos más diversos del mundo de la Casa, de la Oficina y del Contract, se distinguen por su diseño riguroso, por la alta calidad de los materiales y por las tecnologías utilizadas que respetan el medio ambiente.



	PAGE
SEDIE	4 / 47
CHAIRS	ALEXA 24 / 33 DELFINA 42 / 47 EVELINE 34 / 41 OLIVIA 4 / 23
SGABELLI	18 / 21 - 48 / 65
STOOLS	OLIVIA 18 / 21 WELCOME 62 / 65 WELL 56 / 61 ZANZIBAR 48 / 55
TAVOLINI	66 / 85
SIDE TABLES	DESCO 70 / 73 POPPY 66 / 69 WOODY 74 / 77 ZANZIPLANO 78 / 85
TAVOLI	78 / 109
TABLES	ALEX 104 / 109 CONVITO 98 / 103 ENRICO X 92 / 97 FILIPPO 86 / 91 ZANZIPLANO 78 / 85
APPENDIABITI E GRUCCE	124 / 139 - 140 / 167
COAT STANDS AND HANGERS	AIUTO 144 / 147 ALTER EGO 140 / 143 CACTUS 152 / 155 COLMO 178 / 181 CRIBBIO 172 / 177 DOPPIOPETTO 156 / 159 POP 148 / 151 UNPOSTO / DUE-TREPOSTI 160 / 163 GRU 164 / 167 NOX EGO 136 / 139 NOX IPSO 132 / 135 NOX VESTA 124 / 129 NOX VESTA WALL 130 / 131
CESTINI	110 / 126 - 168 / 197
WASTE BASKETS	BIRILLO / BIRILLO PLUS 188 / 193 COLMO 174 / 177 CRIBBIO 168 / 173 ECO / ECO PRO 178 / 183 STATUS 194 / 197 TABOO 184 / 187 NOX 110 / 113 NOX MAGNUM 116 / 119 NOX WALL 122 / 123
PORTAOMBRELLI	110 / 113 - 172 / 201
UMBRELLA STANDS	BIRILLO 188 / 191 COLMO 174 / 177 CRIBBIO 168 / 173 STATUS 194 / 197 NOX 110 / 113
POSACENERE DA TERRA	114 / 115 - 168 / 177 - 188 / 191
FLOOR ASHTRAYS	BIRILLO 188 / 191 COLMO 174 / 177 CRIBBIO 168 / 173 NOX 114 / 115
SET DA SCRIVANIA E PARETE	198 / 217
DESKTOP AND WALL SETS	BABELE 198 / 203 STANDARD / WALL 204 / 211 STATUS 212 / 217
ACCESSORI DA SCRIVANIA	218 / 221
DESKTOP ACCESSORIES	DUPLO 218 / 221 GEMINI 218 / 221 HANNIBAL 218 / 221 MULTIPLOR 218 / 221 NOX 218 / 221 SAFE TRAY 218 / 221

	PAGE
COLLEZIONE IN ACCIAIO INOX STAINLESS STEEL COLLECTION	110 / 139
CESTINI BASKETS	NOX NOX MAGNUM 110 / 113 116 / 119
PORTAOMBRELLI UMBRELLA STANDS	NOX 110 / 113
POSACENERE DA TERRA FLOOR ASHTRAYS	NOX 114 / 115
CESTINI E POSACENERE DA PARETE WALL BASKETS AND ASHTRAYS	NOX WALL 122 / 123
FIORIERE PLANTERS	NOX FLORA 120 / 121
APPENDIABITI COAT STANDS	NOX EGO NOX IPSO NOX VESTA NOX VESTA WALL 136 / 139 132 / 135 124 / 129 130 / 131
SISTEMI LIBRERIA MODULARI MODULAR SHELVING SYSTEMS	222 / 243 BOOX / BOOX DOPPIO TECA TRIESTE 236 / 243 222 / 227 228 / 235
SISTEMA DIVISORIO PARTITION SYSTEM	QUINTA 244 / 249 244 / 249
LETTO MULTIFUNZIONE MULTI-FUNCTIONAL BED	ABITACOLO 250 / 255 250 / 255
SCRITTOIO PER COMPUTER COMPUTER DESK	BANCO LIGHT 256 / 259 256 / 259
CONTENITORE SU RUOTE CABINET ON CASTORS	JOLLY 260 / 263 260 / 263
CARRELLI / VASSOI TROLLEYS / TRAYS	T-TAP TENDER 264 / 271 268 / 271 264 / 267
PORTABOTTIGLIE / PORTARIVISTE BOTTLE-RACKS / MAGAZINE-RACKS	CANTINA PRESS 272 / 275 272 / 275
OROLOGI DA PARETE WALL CLOCKS	APPUNTAMENTO CONTRATTEMPO ORARIO ZERO 276 / 281 276 / 279 276 / 279 280 / 281 280 / 281
REXITE STORY	282 / 285
DESIGNERS	286 / 289
AWARDS	290 / 291
REFERENCES	292 / 295

OLIVIA

design Raul Barbieri

2004

AWARDS

THE CHICAGO ATHENAEUM

2004 – Chicago, U.S.A.

FX INTERNATIONAL INTERIOR DESIGN AWARD (Finalist)

2004 – London, UNITED KINGDOM

19th BIENNIAL OF INDUSTRIAL DESIGN

2004 – Ljubljana, SLOVENIA

GRANDESIGN 2005

2005 – Milano, ITALY

INTERIOR INNOVATION

2006 – Köln, GERMANY



OLIVIA

design Raul Barbieri, 2004

Olivia è un sistema di sedute contraddistinte dalla linea morbida e dal foro rotondo nello schienale: un cerchio perfetto, una vera icona distintiva. Il sistema comprende una grande varietà di tipologie: sedie e poltroncine impilabili, sedie e poltroncine su ruote, ad altezza fissa o regolabile con pistone a gas, sedie con tavoletta scrittoio destra o sinistra, sedie con struttura a slitta o con gambe in massello di faggio tornito, sgabelloni e sedute su barra.

Sedute in polipropilene rinforzato e stabilizzato UV. Strutture in acciaio cromato.

Olivia is a seating system featuring a soft line and a round hole in the backrest: a perfect circle and a truly distinctive icon. The system includes a wide range of models: stackable chairs and armchairs, chairs and armchairs on castors, fixed or adjustable with gas lift adjustable height, chairs with right or left hand writing tablet, chairs with sled frame or with turned solid beechwood legs, bar stools and seats on ganging rail.

Seats in reinforced polypropylene UV stabilized. Frames in chromium-plated steel.



2500. OLIVIA
sedia impilabile
stackable chair

2501. OLIVIA
poltroncina impilabile
stackable armchair

2509. OLIVIA
sedia con tavoletta
chair with writing tablet

2560. OLIVIA Slim
sedia impilabile
stackable chair

Olivia est un système de siège caractérisé par sa ligne douce et son ouverture arrondie dans le dossier, qui forme un cercle parfait, une véritable icône de style. Le système se décline en une grande variété de modèles: chaises et fauteuils empilables, chaises et fauteuils sur roulettes, fixes ou réglables en hauteur par piston à gaz, chaises avec tablette étroite à droite ou à gauche, chaises avec piètement luge ou avec pieds en hêtre massif tourné, tabourets et assises sur poutre. Assises en polypropylène renforcé et stabilisé UV. Structures en acier chromé.

Olivia ist ein Sitzsystem gekennzeichnet durch eine weiche Linienführung und ein rundes Loch in der Rückenlehne: ein perfekter Kreis, eine unverwechselbare Stilikone. Das System umfasst eine Vielzahl von Typologien: stapelbare Stühle und Armlehnstühle, Stühle und Armlehnstühle auf Rollen, starre Ausführung oder höhenverstellbare mit Gasfeder, Stühle mit Klappischen rechts oder links, Stühle mit Kufengestell oder mit Beinen aus massiver Buche, Barhocker und Sitzschalen auf Schiene.

Sitzschalen aus verstärktem Polypropylen UV-beständig. Gestelle aus verchromtem Stahl.

Olivia es un sistema de asientos caracterizados por una línea suave y una abertura redonda en el respaldo: un círculo perfecto, una auténtica marca distintiva. El sistema incluye una amplia variedad de modelos: sillas y silloncitos apilables, sillas y silloncitos sobre ruedas, de altura fija o regulable mediante pistón a gas, sillas con atril abatible derecho o izquierdo, sillas con estructura de patín o con patas de madera de haya maciza torneada, taburetes y asientos en bancada.

Asientos en polipropileno reforzado y estabilizado UV. Estructuras en acero cromado.



2517. OLIVIA Wood
sedia
chair

2502. OLIVIA
sedia girevole su ruote
swivel chair on castors

2505. OLIVIA
poltroncina girevole su ruote
swivel armchair on castors

2508. OLIVIA
sgabello alto impilabile
stackable bar stool

2510. OLIVIA
sedute e tavolini su barra
seats and side tables on ganging rail



2500. OLIVIA
 SEDIA IMPILABILE
 STACKABLE CHAIR

55 x 50 x h 76,5 cm (seduta/seat h 46 cm)
 21,5" x 19,75" x h 30,25" (seat h 18")

Impilabile fino a 10 pezzi
 Stackable up to 10 pieces

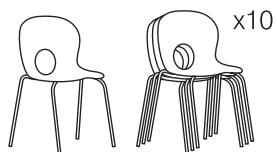

2501. OLIVIA
 POLTRONCINA IMPILABILE
 STACKABLE ARMCHAIR

63 x 50 x h 76,5 cm (seduta/seat h 46 cm)
 24,75" x 19,75" x h 30,25" (seat h 18")

Impilabile fino a 8 pezzi
 Stackable up to 8 pieces

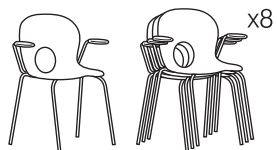

2515. OLIVIA Baby
 SEGGIOLINA IMPILABILE
 STACKABLE CHILDREN CHAIR

55 x 50 x h 66 cm (seduta/seat h 36 cm)
 21,5" x 19,75" x h 26" (seat h 14")

Impilabile fino a 10 pezzi
 Stackable up to 10 pieces

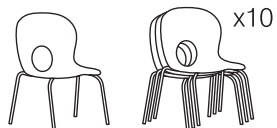



2502. OLIVIA
 SEDIA GIREVOLE SU RUOTE
 CON ALTEZZA FISSA
 SWIVEL CHAIR ON CASTORS
 WITH FIXED HEIGHT
 Ø 62 x h 76,5 cm (seduta/seat h 46 cm)
 dia. 24,5" x h 30,25" (seat h 18")



2503. OLIVIA
 SEDIA GIREVOLE SU RUOTE
 CON ALTEZZA REGOLABILE
 SWIVEL CHAIR ON CASTORS
 WITH ADJUSTABLE HEIGHT
 Ø 62 x h 76,5-86,5 cm (seduta/seat h 46-56 cm)
 dia. 24,5" x h 30,25-34,25" (seat h 18-22")



2504. OLIVIA
 POLTRONCINA GIREVOLE SU RUOTE
 CON ALTEZZA FISSA
 SWIVEL ARMCHAIR ON CASTORS
 WITH FIXED HEIGHT
 Ø 63 x h 76,5 cm (seduta/seat h 46 cm)
 dia. 24,75" x h 30,25" (seat h 18")



2505. OLIVIA
 POLTRONCINA GIREVOLE SU RUOTE
 CON ALTEZZA REGOLABILE
 SWIVEL ARMCHAIR ON CASTORS
 WITH ADJUSTABLE HEIGHT
 Ø 63 x h 76,5-86,5 cm (seduta/seat h 46-56 cm)
 dia. 24,75" x h 30,25-34,25" (seat h 18-22")

OLIVIA

design Raul Barbieri, 2006

Olivia è disponibile anche in una versione con tavoletta scrittoio, destra o sinistra, dotata di snodo antipanico.

Seduta in polipropilene rinforzato e stabilizzato UV. Struttura in acciaio cromato. Tavoletta scrittoio in polimero tecnico nero.

Olivia is also available in a version with a right or left-hand writing tablet provided with anti-panic hinge.

Seat in reinforced polypropylene UV stabilized. Chromium-plated steel frame. Writing tablet in black engineering polymer.

Olivia est également disponible dans une version avec tablette écrivain, à droite ou à gauche, équipée d'un joint anti-panique.

Assise en polypropylène renforcé et stabilisé UV. Structure en acier chromé, tablette écrivain en polymère technique noir.

Olivia ist auch verfügbar in einer Ausführung mit rechtem oder linkem Klappstisch mit Antipanik-Gelenk.

Sitzschale aus verstärktem Polypropylen UV-beständig. Gestell aus verchromtem Stahl, Klappstisch aus schwarzem Technischem-Polymer.

Olivia también está disponible en una versión con atril abatible, derecho o izquierdo, dotado de junta anti-pánico.

Asiento en polipropileno reforzado y estabilizado UV. Estructura en acero cromado, atril en polímero técnico negro.



2509. OLIVIA
 SEDIA CON TAVOLETTA DESTRA
 CHAIR WITH RIGHT TABLET

63 x 50 x h 76,5 cm (seduta/seat h 46 cm)
 24.75" x 19.75" x h 30.25" (seat h 18")

TAVOLETTA
 TABLET

36 x 25 x 1,5 cm – h 69,5 cm
 14.25" x 9.75" x 0.5" – h 27.5"

Impilabile fino a 4 pezzi
 Stackable up to 4 pieces

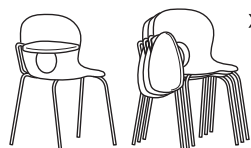

2507. OLIVIA
 SEDIA CON TAVOLETTA SINISTRA
 CHAIR WITH LEFT TABLET

63 x 50 x h 76,5 cm (seduta/seat h 46 cm)
 24.75" x 19.75" x h 30.25" (seat h 18")

TAVOLETTA
 TABLET

36 x 25 x 1,5 cm – h 69,5 cm
 14.25" x 9.75" x 0.5" – h 27.5"

Impilabile fino a 4 pezzi
 Stackable up to 4 pieces

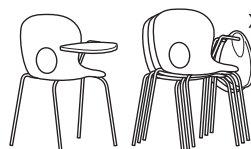



OLIVIA

design Raul Barbieri, 2004

Il pratico giunto di collegamento, unificato per le famiglie Alexa e Olivia (escluse Olivia Slim e Olivia Wood), consente di collegare tra di loro sia le sedie che le poltroncine.

Il carrello Pick-up è il mezzo ideale per spostare velocemente e senza sforzi sia Olivia che Alexa ed Eveline, una volta opportunamente impilate.

Giunto di collegamento in polimero tecnico. Carrello in acciaio verniciato.

The practical connecting joint, the same for Alexa and Olivia (with the exception of Olivia Slim and Olivia Wood), allows the connection of both chairs and armchairs together.

The Pick-up trolley is the ideal tool for quickly and effortlessly moving Olivia, Alexa and Eveline, once properly stacked.

Connecting joint in engineering polymer. Trolley in painted steel.

Le pratique crochet de connexion, unifié pour les gammes Alexa et Olivia (à l'exclusion de Olivia Slim et Olivia Wood), permet de connecter entre eux soit les chaises soit les fauteuils.

Le chariot Pick-up est le moyen idéal pour déplacer rapidement et sans forcer les chaises Olivia, Alexa, et Eveline, une fois correctement empilées.

Crochet de connexion en polymère technique. Chariot en acier verni.

Das praktische einheitliche Verbindungsteil für Olivia und Alexa (ausgenommen Olivia Slim und Olivia Wood) ermöglicht das Verbinden der Stühle und Armlehnstühle.

Der Wagen Pick-up ist ideal, um gestapelte Olivia, Alexa und Eveline Stühle schnell und ohne Kraftaufwand zu verschieben.

Verbindungsteil aus Technischem-Polymer. Wagen aus lackiertem Stahl.

La práctica junta de unión entre sillas, unificada para las familias Alexa y Olivia (con la excepción de Olivia Slim y Olivia Wood), permite acoplar sillas y también silloncitos.

El carrito Pick-up es el medio ideal para desplazar de manera rápida y sin esfuerzo las sillas Olivia, Alexa y Eveline, una vez adecuadamente apiladas.

Junta de unión en polímero técnico. Carrito en acero pintado.



116. PICK-UP

CARRELLO

TROLLEY

45 x 65 x h 110 cm

17.75" x 25.5" x h 43.25"

Portata 10 sedie / 8 poltroncine

Max load 10 chairs / 8 armchairs

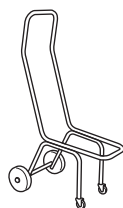

114.

GIUNTO DI COLLEGAMENTO

CONNECTING JOINT

14,5 x 3 x h 7 cm

5.75" x 1.25" x h 2.75"





OLIVIA Slim

design Raul Barbieri, 2016

Lo snello profilo del modello con struttura a slitta si sposa perfettamente alle linee morbide della seduta e del foro rotondo nello schienale, offrendo interessanti alternative per ambientazioni sia domestiche, che collettive.

Seduta in polipropilene rinforzato e stabilizzato UV, struttura in acciaio cromato. Giunti di collegamento in polimero tecnico.

The slim profile of the model with sled frame blends perfectly with the soft lines of the seat and the round hole in the backrest, offering interesting background options both in the home and communal spaces.

Seat in reinforced polypropylene UV stabilized. Chromium-plated steel frame. Connecting joints in engineering polymer.

Le profil élancé du modèle avec piètement luge épouse parfaitement les lignes douces de l'assise et de l'ouverture arrondis dans le dossier, offrant d'intéressantes alternatives de décoration, dans des contextes familiaux ou collectifs.

Assise en polypropylène renforcé et stabilisé UV, structure en acier chromé. Crochets de connexion en polymère technique.

Das schlanke Profil des Modells mit Kufengestell passt perfekt zu der weichen Linienführung der Sitzschalen und dem kreisrunden Loch in der Rückenlehne und bietet interessante Alternative im privaten und beruflichen Umfeld.

Sitzschale aus verstärktem Polypropylen UV-beständig, Gestell aus verchromtem Stahl. Verbindungsteile aus Technischem-Polymer.

El perfil liviano del modelo con estructura de patín encaja perfectamente con las líneas suaves de la silla y la abertura redonda del respaldo, ofreciendo interesantes alternativas de ambientaciones tanto en entornos domésticos como colectivos.

Asiento en polipropileno reforzado y estabilizado UV, estructura en acero cromado. Juntas de unión en polímero técnico.

2560. OLIVIA Slim

SEDIA IMPILABILE

STACKABLE CHAIR

55 x 50 x h 76,5 (seduta/seat h 46) cm
21.5" x 19.5" x h 30.25" (seat h 18")

Impilabile fino a 10 pezzi
Stackable up to 10 pieces

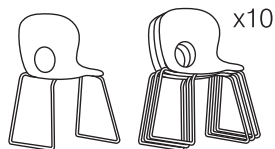

2561. OLIVIA Slim

POLTRONCINA IMPILABILE

STACKABLE ARMCHAIR

63 x 50 x h 76,5 (seduta/seat h 46) cm
24.75" x 19.5" x h 30.25" (seat h 18")

Impilabile fino a 8 pezzi
Stackable up to 8 pieces

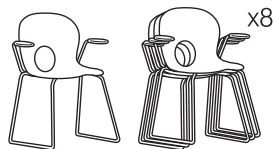

2562-3. OLIVIA Slim

SEDIA CON TAVOLETTA

DESTRA / SINISTRA

CHAIR WITH TABLET

RIGHT / LEFT

63 x 50 x h 76,5 cm (seduta/seat h 46 cm)

24.75" x 19.75" x h 30.25" (seat h 18")

TAVOLETTA

TABLET

36 x 25 x 1,5 cm – h 69,5 cm

14.25" x 9.75" x 0.5" – h 27.5"

Impilabile fino a 4 pezzi

Stackable up to 4 pieces

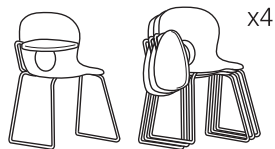

2562.

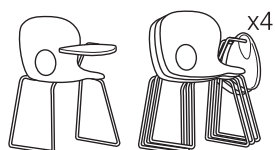

2563.

122.

GIUNTI DI COLLEGAMENTO (COPPIA)

CONNECTING JOINTS (PAIR)

3,5 x 3,1 x h 1,6 cm

1.5" x 1.25" x h 0.5"





OLIVIA

design Raul Barbieri, 2006

La seduta Olivia è disponibile anche su barre da 2, 3 e 4 posti, tutte attrezzabili con sedute, tavolini e braccioli.

Sedute in polipropilene rinforzato e stabilizzato UV. Tavolini in stratificato melaminico antigraffio HPL 12 mm. Braccioli e gambe in acciaio cromato, barre in acciaio verniciato alluminio.

The Olivia seat is also available on ganging rails of 2, 3 and 4 places, all of which can be fitted with seats, side tables and armrests.

Seats in reinforced polypropylene UV stabilized. Table-tops in scratch-resistant high pressure melamine laminate HPL 12 mm. Arms and legs in chromium-plated steel, steel rails aluminium painted.

L'assise Olivia est également disponible sur poutres de 2, 3 et 4 places, qui peuvent toutes être équipées d'assises, petites tables et accoudoirs.

Assise en polypropylène renforcé et stabilisé UV. Plateaux en stratifié mélaminique anti-rayures HPL 12 mm. Accoudoirs et pieds en acier chromé, poutres en acier verni aluminium.

Olivia ist auch auf Schiene für 2, 3 und 4 Plätze verfügbar, welche mit Sitzschalen, Tischchen und Armlehnen ausgestattet werden können.

Sitzschalen aus verstärktem Polypropylen UV-beständig. Tischplatten aus kratzfestem Hochdruck-Schichtpreßstoff HPL 12 mm. Armlehnen und Beine aus verchromtem Stahl, Schiene aus Stahl alufarbig lackiert.

El asiento Olivia también está disponible en bancadas de 2, 3 y 4 plazas, que pueden ser equipadas con asientos, mesitas y brazos.

Asientos en polipropileno reforzado y estabilizado UV. Mesitas en compacto melamínico anti-arañazos HPL 12 mm. Brazos y patas en acero cromado, bancadas en acero pintado aluminio.

2510. OLIVIA SEDUTA

SEAT
46 x 50 x h 41 cm
18" x 19.75" x h 16.25"



2513. OLIVIA BRACCIOLO

ARM
25,5 x h 26,5 cm
10" x h 10.5"



2511. OLIVIA TAVOLINO

SIDE TABLE
45 x 45 cm
17.75" x 17.75"



2512. OLIVIA BARRA CON GAMBE

GANGING RAIL WITH LEGS

- 02.** 95 (+10) x 60 x h 40 cm (2 posti)
37.5" (+4") x 23.5" x h 15.75" (2 spaces)
- 03.** 140 (+16) x 60 x h 40 cm (3 posti)
55" (+6.5") x 23.5" x h 15.75" (3 spaces)
- 04.** 195 (+16) x 60 x h 40 cm (4 posti)
77" (+6.5") x 23.5" x h 15.75" (4 spaces)

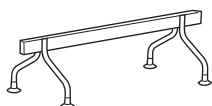

ESEMPI DI COMPOSIZIONE EXAMPLES OF COMPOSITIONS

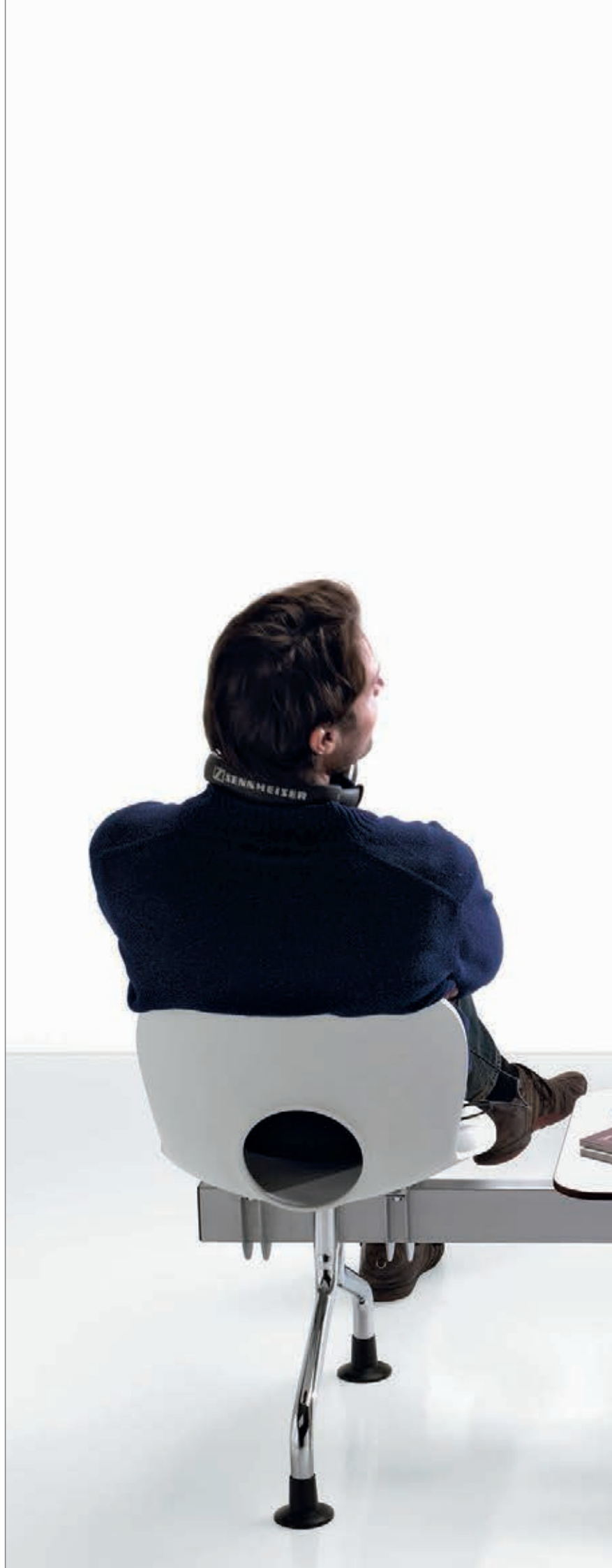
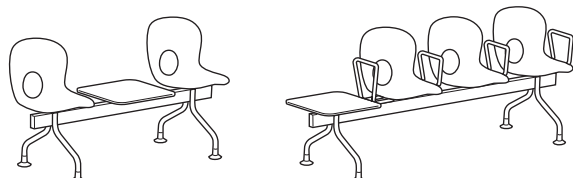



OLIVIA

design Raul Barbieri, 2005

Il sistema Olivia comprende anche due sgabelloni con sedute alte rispettivamente 67 e 79 cm. Dotati di un comodo appoggiapiedi, sono davvero perfetti per bar e aree break aziendali, ma anche per il bancone di molte moderne cucine domestiche.

Sedute in polipropilene rinforzato e stabilizzato UV. Strutture in acciaio cromato.

The Olivia system also includes two bar stools with a seating height of 67 and 79 cm respectively, equipped with a comfortable footrest, ideal for bars and corporate break areas, but also for the counter of many modern household kitchens.

Seat in reinforced polypropylene UV stabilized. Chromium-plated steel frame.

Le système Olivia comprend également deux tabourets avec assise à hauteur respectueuse 67 et 79 cm. Equipées d'un repose-pied confortable, il sont vraiment adéquats pour les bars et les espaces pause des entreprises, mais aussi pour le comptoir de nombreuses cuisines domestiques modernes.

Assises en polypropylène renforcé et stabilisé UV. Structures en acier chromé.

Das Olivia-System umfasst auch zwei Barhocker mit jeweils 67 und 79 cm Sitzhöhe und bequemer Fußstütze, ideal für Bars und Kaffeeküchen in Unternehmen oder für die Tresen vieler moderner Küchen zu Hause.

Sitzschalen aus verstärktem Polypropylen UV-beständig. Gestelle aus verchromtem Stahl.

El sistema Olivia también incluye dos taburetes con altura 67 y 79 cm, dotados de un cómodo reposapiés, verdaderamente perfectos para bares y zonas break de empresas, así como para la barra americana de muchas cocinas domésticas modernas.

Asientos en polipropileno reforzado y estabilizado UV. Estructuras en acero cromado.

2506. OLIVIA
SGABELLONE MEDIO IMPILABILE
STACKABLE MEDIUM STOOL

55 x 52 x h 96 cm (seduta/seat h 67 cm)
21.5" x 20.5" x h 37.75" (seat h 26.5")

Impilabile fino a 4 pezzi
Stackable up to 4 pieces

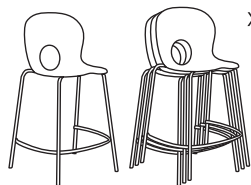

x4

2508. OLIVIA
SGABELLONE ALTO IMPILABILE
STACKABLE HIGH STOOL

56,5 x 54 x h 108 cm (seduta/seat h 79 cm)
22.25" x 21.25" x h 42.5" (seat h 31")

Impilabile fino a 4 pezzi
Stackable up to 4 pieces

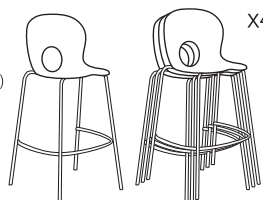

x4





OLIVIA Wood

design Raul Barbieri, 2015

Il colore caldo delle gambe in faggio si abbina perfettamente ai colori della seduta di Olivia nella sua versione Baby, per i più piccini, ma si intona altrettanto bene anche ai maestosi e comodissimi sgabelli, ideali per bar e aree break aziendali o per i banconi di molte moderne cucine domestiche.

Sedute in polipropilene rinforzato e stabilizzato UV, gambe in legno di faggio massello tornito. Appoggiatepiedi degli sgabelli in acciaio cromato.

The warm colour of the legs in beechwood is a perfect match with the seat colours of Olivia in its Baby version for children, but it fits in just as well with the majestic and comfortable bar stools, ideal for bars and corporate break rooms or counters in many modern kitchens.

Seats in reinforced polypropylene UV stabilized. Legs in solid turned beechwood. Stools' footrests in chromium-plated steel.

La couleur chaude des pieds en hêtre s'accorde parfaitement aux teintes de l'assise Olivia dans sa version Baby, pour les plus petits, mais elle s'accorde tout aussi bien aux majestueux et confortables tabourets, parfaitement adaptés aux bars, aux espaces pause des entreprises ou aux comptoirs de nombreuses cuisines domestiques modernes.

Assises en polypropylène renforcé et stabilisé UV, pieds en bois de hêtre massif tourné. Repose-pieds de tabourets en acier chromé.

Die warme Farbe der Beine aus Buchenholz passt perfekt zu den Farben der Sitze von Olivia in der Baby Ausführung, als Kinderhochstuhl, passt aber auch gut zu den imposanten und sehr komfortablen Barhockern, die sich ideal für Bars und Kaffeeküchen in Unternehmen oder für die Tresen vieler moderner Küchen zu Hause eignen.

Sitzschalen aus verstärktem Polypropylen UV-beständig, Beine aus massiv-gedrehtem Buchenholz. Fußstütze an den Hockern aus verchromtem Stahl.

El color cálido de las patas en madera de haya combina a la perfección con los colores del asiento Olivia en su versión Baby, para los más pequeños, y combina igual de bien con los majestuosos y comodísimos taburetes, ideales para bares y zonas break de empresas o para la barra americana de muchas cocinas domésticas modernas.

Asientos en polipropileno reforzado y estabilizado UV, patas torneadas en madera de haya maciza. Reposapiés de los taburetes en acero cromado.



2517. OLIVIA Wood

SEDIA

CHAIR

55 x 50 x h 76,5 cm (seduta/seat h 46 cm)
21.5" x 19.75" x h 30.25" (seat h 18")



2516. OLIVIA Wood Baby

SEGGIOLINA

CHILDREN CHAIR

55 x 50 x h 66 cm (seduta/seat h 36 cm)
21.5" x 19.75" x h 26" (seat h 14")



2518. OLIVIA Wood L

SGABELLONE MEDIO

MEDIUM STOOL

55 x 52 x h 96 cm (seduta/seat h 67 cm)
21.5" x 20.25" x h 37.75" (seat h 26.5")



2519. OLIVIA Wood XL

SGABELLONE ALTO

HIGH STOOL

56,5 x 54 x h 108 cm (seduta/seat h 79 cm)
22" x 21" x h 42.5" (seat h 31")

2518.

2519.







ALEXA

design Raul Barbieri
2006

AWARDS

21th BIENNIAL OF INDUSTRIAL DESIGN
2008 – Ljubljana, SLOVENIA



ALEXA

design Raul Barbieri, 2006

Straordinariamente confortevole e caratterizzata da una elegante struttura in alluminio pressofuso che le conferisce una linea leggera e sensuale, Alexa è davvero l'ideale sia per spazi collettivi come per la casa.

Seduta e schienale in polipropilene rinforzato e stabilizzato UV. Struttura e braccioli in alluminio pressofuso, lucidato, cromato o verniciato antigraffio in tinta con seduta e schienale.

Extraordinarily comfortable and accented with an elegant die-cast aluminium frame which gives it a profile that is both light and sensual, Alexa is perfect for both communal spaces and the home environment.

Seat and back in reinforced polypropylene UV stabilized. Frame and arms in die-cast aluminium, polished, chromium plated or scratch-resistant painted in the same colour as the seat and back.

Extraordinairement confortable et caractérisée par une élégante structure en aluminium moulé sous pression qui lui confère une ligne légère et sensuelle, Alexa est vraiment idéale pour les espaces collectifs comme pour la maison.

Assise et dossier en polypropylène renforcé et stabilisé UV. Structure et accoudoirs en aluminium moulé sous pression, poli, chromé ou verni anti-rayures dans la même couleur que le siège et le dossier.

Außerordentlich komfortabel und von einer eleganten Aluminium-Spritzguss Struktur gekennzeichnet, die eine leichte und sinnliche Linie ergibt, Alexa ist wirklich das Ideal sowohl für den öffentlichen Bereich, als auch für das private Haus.

Sitz und Rücken aus verstärktem Polypropylen UV-beständig. Gestell und Armlehnen aus Aluminium-Spritzguss, poliert, verchromt oder kratzfest lackiert in gleicher Farbe wie Sitz und Rücken.

Extraordinariamente cómoda y caracterizada por una elegante estructura en aluminio moldeado a presión que le confiere una línea ligera y sensual, Alexa es verdaderamente ideal tanto para espacios colectivos como para el hogar.

Asiento y respaldo en polipropileno reforzado y estabilizado UV. Estructura y brazos en aluminio moldeado a presión, pulido, cromado o pintado anti-arañazos a juego con el color del asiento y respaldo.



2520. ALEXA
 SEDIA IMPILABILE
 STACKABLE CHAIR

50,5 x 54 x h 83 cm (seduta/seat h 46 cm)
 19.75" x 21.25" x h 32.75" (seat h 18")

Impilabile fino a 8 pezzi
 Stackable up to 8 pieces

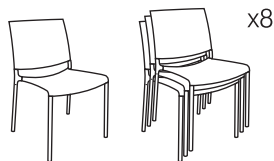

2521. ALEXA
 POLTRONCINA IMPILABILE
 STACKABLE ARMCHAIR

56,5 x 54 x h 83 cm (seduta/seat h 46 cm)
 22.25" x 21.25" x h 32.75" (seat h 18")

Impilabile fino a 7 pezzi
 Stackable up to 7 pieces

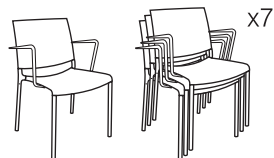



ALEXA

design Raul Barbieri, 2009

Alexa è disponibile anche in versione con tavoletta scrittoio destra o sinistra, dotata di snodo antipanico.

Seduta e schienale in polipropilene rinforzato e stabilizzato UV. Struttura in alluminio pressofuso lucidato, cromato o verniciato antigraffio in tinta con seduta e schienale. Tavoletta in polimero tecnico nero.

Alexa is also available in a version with a right or left-hand writing tablet, provided with anti-panic hinge.

Seat in reinforced polypropylene UV stabilized. Frame in die-cast aluminium, polished, chromium plated or scratch-resistant painted in the same colour as the seat and back. Writing tablet in black engineering polymer.

Alexa est également disponible dans une version avec tablette écrioire, à droite ou à gauche, équipée d'un joint anti-panique.

Assise et dossier en polypropylène renforcé et stabilisé UV. Structure en aluminium moulé sous pression, poli, chromé ou verni anti-rayures dans la même couleur que le siège et le dossier. Tablette en polymère technique noir.

Alexa ist auch in der Ausführung mit rechtem oder linkem Klappstisch mit Antipanik-Gelenk verfügbar.

Sitz und Rücken aus verstärktem Polypropylen UV-beständig. Gestell aus Aluminium-Spritzguss, poliert, verchromt oder kratzfest lackiert in gleicher Farbe wie Sitz und Rücken. Klappstisch aus schwarzem Technischem-Polymer.

Alexa también está disponible en una versión con atril abatible, derecho o izquierdo, dotado de junta anti-pánico.

Asiento y respaldo en polipropileno reforzado y estabilizado UV. Estructura en aluminio moldeado a presión, pulido, cromado o pintado anti-arañazos a juego con el color del asiento y respaldo. Mesita en polímero técnico negro.

2529. ALEXA
 SEDIA CON TAVOLETTA DESTRA
 CHAIR WITH RIGHT TABLET

57 x 54 x h 83 cm (seduta/seat h 46 cm)
 22.5" x 21.25" x h 32.75" (seat h 18")

TAVOLETTA / TABLET

36 x 25 x 1,5 cm – h 69,5 cm
 14.25" x 9.75" x 0.5" – h 27.5"

Impilabile fino a 4 pezzi
 Stackable up to 4 pieces

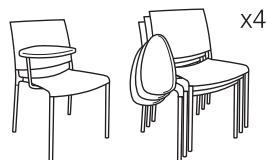

2530. ALEXA
 SEDIA CON TAVOLETTA SINISTRA
 CHAIR WITH LEFT TABLET

57 x 54 x h 83 cm (seduta/seat h 46 cm)
 22.5" x 21.25" x h 32.75" (seat h 18")

TAVOLETTA
 TABLET

36 x 25 x 1,5 cm – h 69,5 cm
 14.25" x 9.75" x 0.5" – h 27.5"

Impilabile fino a 4 pezzi
 Stackable up to 4 pieces

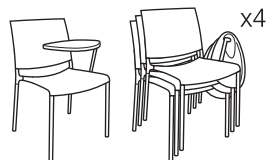

116. PICK-UP
 CARRELLO
 TROLLEY

45 x 65 x h 110 cm
 17.75" x 25.5" x h 43.25"

Portata 8 sedie / 7 poltroncine
 Max load 8 chairs / 7 armchairs

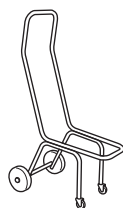

114.
 GIUNTO DI COLLEGAMENTO
 CONNECTING JOINT

14,5 x 3 x h 7 cm
 5.75" x 1.25" x h 2.75"





ALEXA

design Raul Barbieri, 2009

L'intera famiglia Alexa è disponibile anche nelle versioni con seduta e schienale rivestiti in cuoio o in ecopelle curate nei minimi dettagli, davvero perfette per la casa come per eleganti spazi collettivi.

Seduta e schienale in polipropilene rinforzato rivestiti in cuoio o ecopelle. Struttura e braccioli in alluminio pressofuso, lucidato, cromato o verniciato antigraffio in tinta con seduta e schienale.

The entire Alexa family is also available with leather or with eco-leather upholstered seats and back with a focus on details, ideal for the home as well as for elegant communal spaces.

Seat and back in reinforced polypropylene upholstered with leather or eco-leather. Frame and arms in die-cast aluminium, polished, chromium plated or scratch-resistant painted in the same colour as the seat and back.

Toute la gamme Alexa est également disponible avec assise et dossier recouverts en cuir ou en ecopelle avec une grande attention apportée aux détails, vraiment idéale pour la maison comme pour d'élégants espaces collectifs.

Siège et dossier en polypropylène renforcé recouverts en cuir ou ecopelle. Structure et accoudoirs en aluminium moulé sous pression, poli, chromé ou verni anti-rayures dans la même couleur que le siège et le dossier.

Die ganze Alexa-Produktfamilie ist auch verfügbar mit Sitz und Rücken bezogen mit Leder oder Eco-Leder. Die sorgfältig verarbeiteten Stühle eignen sich perfekt für zu Hause oder für elegante öffentliche Räume.

Sitz und Rücken aus verstärktem Polypropylen bezogen mit Leder oder Eco-Leder. Gestell und Armlehnen aus Aluminium-Spritzguss, poliert, verchromt oder kratzfest lackiert in gleicher Farbe wie Sitz und Rücken.

Toda la familia Alexa también está disponible en versiones con asiento y respaldo tapizados en cuero o eco-piel, realizadas con la máxima atención al detalle, verdaderamente perfectas para el hogar y para elegantes espacios colectivos.

Asiento y respaldo en polipropileno reforzado tapizados en cuero o eco-piel. Estructura y brazos en aluminio moldeado a presión, pulido, cromado o pintado anti-arañazos a juego con el color del asiento y respaldo.

2520. ALEXA
 SEDIA IMPILABILE
 STACKABLE CHAIR

50,5 x 54 x h 83 cm (seduta/seat h 46 cm)
 19.75" x 21.25" x h 32.75" (seat h 18")

Impilabile fino a 8 pezzi
 Stackable up to 8 pieces

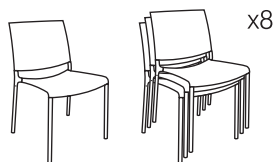

2521. ALEXA
 POLTRONCINA IMPILABILE
 STACKABLE ARMCHAIR

56,5 x 54 x h 83 cm (seduta/seat h 46 cm)
 22.25" x 21.25" x h 32.75" (seat h 18")

Impilabile fino a 7 pezzi
 Stackable up to 7 pieces

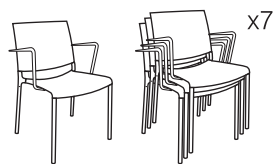

2529-30. ALEXA
 SEDIA CON TAVOLETTA
 DESTRA / SINISTRA
 CHAIR WITH TABLET
 RIGHT / LEFT

57 x 54 x h 83 cm (seduta/seat h 46 cm)
 22.5" x 21.25" x h 32.75" (seat h 18")

TAVOLETTA
 TABLET
 36 x 25 x 1,5 cm – h 69,5 cm
 14.25" x 9.75" x 0.5" – h 27.5"

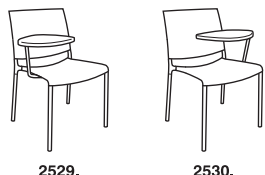







EVELINE

design Raul Barbieri
2008

AWARDS

TRADITION / INNOVATION (Triennale di Milano)
2012 – Shanghai, CHINA



EVELINE

design Raul Barbieri, 2008

Una sedia elegante e straordinariamente confortevole, leggera ma estremamente robusta, perfetta sia per ambiti privati che per spazi collettivi.

Stampata in un unico pezzo in polycarbonato flame retardant stabilizzato UV, in colori trasparenti o solidi.

An elegant, amazingly comfortable, lightweight but very durable chair, perfect for both private areas and communal spaces.

Moulded in one piece, in flame retardant polycarbonate UV stabilized, in transparent or solid colours.

Une chaise élégante et incroyablement confortable, légère mais d'une grande résistance qui la rend parfaitement adaptée aux espaces privés et collectifs.

Moulée en une seule pièce en polycarbonate flame retardant stabilisé UV, dans des couleurs transparentes ou solides.

Ein eleganter, erstaunlich bequemer und leichter Stuhl mit erhöhter Robustheit, der sich perfekt für private und öffentliche Bereiche eignet.

Einspritzguss in einem Stück aus schwer entflammbarem Polycarbonat UV-beständig, in transparenten oder durchgefärbten Farben.

Silla elegante e increíblemente cómoda, ligera pero de alta resistencia estructural, perfecta tanto para ambientes privados como para espacios colectivos.

Moldeada en una sola pieza en polycarbonato flame retardant estabilizado UV, en colores transparentes u opacos.

**2540. EVELINE**
SEDIA IMPILABILE
STACKABLE CHAIR

48,5 x 53,5 x h 82,5 cm (seduta/seat h 47 cm)
19" x 21" x h 32,5" (seat h 18,5")

Impilabile fino a 7 pezzi
Stackable up to 7 pieces

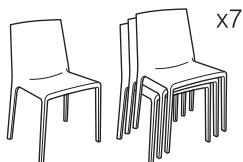
**116. PICK-UP**
CARRELLO
TROLLEY

45 x 65 x h 110 cm
17.75" x 25.5" x h 43.25"

Portata 7 sedie
Max load 7 chairs

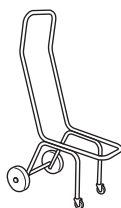
**114.**
GIUNTO DI COLLEGAMENTO
CONNECTING JOINT

14,5 x 3 x h 7 cm
5.75" x 1.25" x h 2.75"













DELFINA

design Enzo Mari
1979



XI COMPASSO D'ORO
1979 – Milano, ITALY



DELFINA

design Enzo Mari, 1979

Un classico esempio del minimalismo di Enzo Mari, premiato con il Compasso d'Oro nel 1979 e ancora oggi in grado di emozionare per la sua attualità. Le fodere in tessuto si possono mettere e togliere con estrema facilità, grazie a generose cerniere lampo ad alta resistenza che ne accentuano l'aspetto giovane e spigliato.

Struttura in tondino d'acciaio cromato, rivestimenti in 100% cotone Kvadrat® o in 100% poliestere Trevira® CS.

A classic example of minimalism by Enzo Mari, awarded the Compasso d'Oro in 1979 and still capable of stirring emotions with its modern style. The fabric covers can very easily be removed thanks to large, strong zippers which highlight its youthful, confident look.

Chromium plated steel rod frame. Covers in Kvadrat® 100% cotton or in Trevira® CS 100% polyester.

Un exemple classique du minimalisme d'Enzo Mari, récompensé par un Compasso d'Oro en 1979 et qui attire encore beaucoup par son design toujours actuel. Le revêtement en tissu pouvant être placé et enlevé très facilement, grâce à des amples fermetures à glissière haute résistance qui accentuent le look jeune et désinvolte.

Structure en tige d'acier chromé, revêtement en 100% coton Kvadrat® ou en 100% polyester Trevira® CS.

Ein klassisches Beispiel des Minimalismus von Enzo Mari, der 1979 mit dem Compasso d'Oro ausgezeichnet wurde, und noch immer aufgrund seiner Aktualität begeistert. Die Stoffbezüge können mit großer Leichtigkeit abgenommen werden, aufgrund der hoch strapazierfähigen Reißverschlüsse, die dem Stuhl zusätzlich ein jugendliches und luftiges Aussehen verleihen. Verchromtes Stahlrohrgestell, Überzüge aus Kvadrat® 100% Baumwolle oder aus Trevira® CS 100% Polyester.

Un ejemplo clásico del minimalismo de Enzo Mari, premiado con el Compasso d'Oro en 1979 y aún capaz de emocionar por su actualidad. Las fundas de tela se pueden poner y quitar con extrema facilidad gracias a cremalleras de alta resistencia que acentúan el aspecto juvenil e informal.

Estructura en barilla de acero cromado, fundas en 100% algodón Kvadrat® o en 100% poliéster Trevira® CS.



2550. DELFINA
 SEDIA IMPILABILE
 STACKABLE CHAIR

48 x 57 x h 79 cm (seduta/seat h 47 cm)
 19" x 22.5" x h 31" (seat h 18.5")

Impilabile fino a 12 pezzi
 Stackable up to 12 pieces

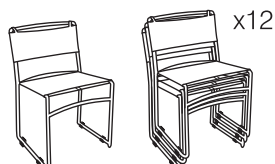







ZANZIBAR

design Raul Barbieri

2001

AWARDS

NEOCON 2001 (Best of Show)
2001 – Chicago, U.S.A.

18th BIENNIAL OF INDUSTRIAL DESIGN
2002 – Ljubljana, SLOVENIA

PREMIO CATAS
2002 – Udine, ITALY

FX INTERNATIONAL INTERIOR DESIGN AWARD (Finalist)
2003 – London, UNITED KINGDOM

THE CHICAGO ATHENAEUM
2003 – Chicago, U.S.A.



ZANZIBAR

design Raul Barbieri, 2001

Grazie alla sua caratteristica seduta a sella, lo sgabello Zanzibar favorisce in modo naturale una postura ergonomicamente corretta. Oltre alla classica versione regolabile in altezza con pistone a gas (50/75 cm), sono disponibili anche due modelli con altezza fissa, 65 e 77 cm e un modello con fissaggio a pavimento.

Seduta e cono in polimero tecnico con pulsanti di regolazione cromati. Gamba, appoggiapiedi e base in acciaio cromato.

Thanks to its characteristic saddle seat, the Zanzibar stool naturally encourages an ergonomically correct posture. In addition to the classic version, with gas lift adjustable height (50/75 cm), two fixed height models at 65 and 77 cm are also available, as well as a model that can be fixed to the floor.

Engineering polymer seat and cone with chrome control push buttons. Leg, footrest and base in chromium plated steel.

Grâce à sa caractéristique assise en forme de selle, le tabouret Zanzibar favorise naturellement une posture ergonomique correcte. En plus de la version classique réglable en hauteur par un piston à gaz (50/75 cm), ils sont également disponibles deux modèles à hauteur fixe, 65 et 77 cm et en un modèle avec fixation au sol.

Assise et cône en polymère technique avec poussoirs de réglage chromés. Pied, repose-pied et base en acier chromé.

Mit seiner charakteristischen sattelförmigen Sitzfläche, fördert der Hocker Zanzibar auf natürliche Weise eine ergonomisch korrekte Haltung. Neben der klassischen, höhenverstellbaren Version mit Gasfeder (50/75 cm), sind auch zwei Modelle mit starrer Sitzhöhe, 65 und 77 cm und ein Modell mit Fußbodenbefestigung erhältlich.

Sitz und Kegel aus Technischem-Polymer mit verchromten Einstelltasten. Fuß, Fußstütze und Basis aus verchromtem Stahl.

Gracias a su característico asiento, en forma de silla de montar, el taburete Zanzibar favorece de manera natural una postura ergonómicamente correcta. Además de la versión clásica de altura regulable mediante pistón a gas (50/75 cm), también están disponibles dos modelos con altura fija, 65 y 77 cm y un modelo con fijación al suelo.

Asiento y cono en polímero técnico con pulsadores de regulación cromados. Pata, reposapiés y base en acero cromado.

2210. ZANZIBAR
SGABELLO CON ALTEZZA REGOLABILE
STOOL WITH ADJUSTABLE HEIGHT
Ø 38 x h 50-75 cm
dia. 15" x h 19.75-29.5"

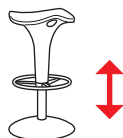

2212-3. ZANZIBAR
SGABELLO CON ALTEZZA FISSA
STOOL WITH FIXED HEIGHT

2212. Ø 38 x h 65 cm
dia. 15" x h 25.5"

2213. Ø 38 x h 77 cm
dia. 15" x h 30.25"

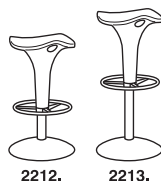

2212.

2213.

2214. ZANZIBAR
SGABELLO CON ALTEZZA REGOLABILE
E FISSAGGIO A PAVIMENTO
STOOL WITH ADJUSTABLE HEIGHT
AND FLOOR FIXING JOINT
Ø 38 x h 50-75 cm
dia. 15" x h 19.75-29.5"

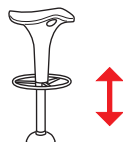











WELL

design Raul Barbieri
2003

AWARDS

19th BIENNIAL OF INDUSTRIAL DESIGN
2004 – Ljubljana, SLOVENIA



WELL

design Raul Barbieri, 2003

Famiglia di sgabelli dalla caratteristica seduta a sella che favorisce in modo naturale una postura ergonomicamente corretta. Mentre il modello base, alto 45 cm e impilabile fino a 20 pezzi è ideale per accogliere ospiti imprevisti o piccole riunioni informali, gli sgabelli medio e alto, rispettivamente 65 e 77 cm, dotati di comodi appoggiatesta, sono invece perfetti per bar e aree break aziendali.

Sedute in polimero tecnico. Struttura in acciaio cromato.

A family of stools with a characteristic saddle seat which naturally encourages an ergonomically correct posture. While the basic model, 45 cm high and stackable up to 20 pieces, is ideal for accommodating unexpected guests or small informal meetings, the medium and high stools, 65 and 77 cm respectively, with comfortable foot rest, are perfect for bars and corporate break areas.

Seats in engineering polymer. Chromium plated steel frame.

Famille de tabourets avec assise caractéristique en forme de selle pour favoriser naturellement une posture ergonomique correcte. Tandis que le modèle de base, haute 45 cm et empilable jusqu'à 20 pièces est idéal pour accueillir des invités inattendus ou pour tenir de petites réunions informelles, les tabourets moyens et hauts (65 et 77 cm), avec repose-pieds confortables, sont parfaits pour les bars et les espaces pause des entreprises.

Assises en polymère technique. Structure en acier chromé.

Hocker-Produktfamilie, die mit ihren charakteristischen, sattelförmigen Sitzen auf natürliche Weise eine ergonomisch korrekte Haltung fördert. Während das 45 cm hohe Basismodell, das sich bis zu 20-mal stapeln lässt, ideal für unerwartete Gäste oder kleine informelle Meetings geeignet ist, sind die mittleren bis hohen Hocker (65 und 77 cm), mit bequemer Fußstütze, perfekt für Bars und Kaffeeküchen in Unternehmen.

Sitze aus Technischem-Polymer. Gestell aus verchromtem Stahl.

Familia de taburetes caracterizados por el asiento en forma de silla de montar que favorece de manera natural una postura ergonómicamente correcta. El modelo básico, con altura 45 cm y apilable hasta 20 unidades, resulta ideal para recibir a invitados inesperados o para pequeñas reuniones informales, mientras que los taburetes medio y alto, 65 y 77 cm respectivamente, ambos dotados de un cómodo reposapiés, resultan perfectos para bares y zonas break de empresas.

Asientos en polímero técnico. Estructura en acero cromado.



2260. WELL
SGABELLO IMPILABILE
STACKABLE STOOL

Ø 46 x h 45 cm
dia. 18" x h 17.75"

Impilabile fino a 20 pezzi
Stackable up to 20 pieces



2261-2. WELL
SGABELLONE MEDIO / ALTO
MEDIUM / HIGH STOOL

2261. Ø 52 x h 65 cm
dia. 20.5" x h 25.5"

2262. Ø 54 x h 77 cm
dia. 21.25" x h 30.25"



2261.

2262.







WELCOME

design Raul Barbieri
2003

AWARDS

THE CHICAGO ATHENAEUM
2003 – Chicago, U.S.A.

19th BIENNIAL OF INDUSTRIAL DESIGN
2004 – Ljubljana, SLOVENIA



WELCOME

design Raul Barbieri, 2003

Pratico e disinvolto sgabello su ruote con altezza regolabile mediante pistone a gas (43/53 cm), dotato di una caratteristica seduta a sella che favorisce una postura ergonomicamente corretta.

Seduta e dischetti copri-ruote in polimero tecnico con pulsanti di regolazione cromati. Struttura in acciaio cromato.

Easy and practical stool on castors with gas lift adjustable height (43/53 cm), fitted with a characteristic saddle seat that encourages an ergonomically correct posture.

Seat and castor cover discs in engineering polymer with chrome control push buttons. Chromium plated steel frame.

Confortable et pratique tabouret sur roulettes, réglable en hauteur (43/53 cm) par piston à gaz, caractérisé par son assise en forme de selle qui favorise une correcte posture ergonomique. Assise et disquettes couvre-roulettes en polymère technique, poussoirs de réglage chromés. Structure en acier chromé.

Ein praktischer und legerer, mit Gasfeder höhenverstellbarer (45/53 cm) Drehhocker auf Rollen, der mit seinem charakteristischen, sattelförmigen Sitz auf natürliche Weise eine ergonomisch korrekte Haltung fördert.

Sitz und Radkappen aus Technischem-Polymer mit verchromten Einstelltasten. Gestell aus verchromtem Stahl.

Práctico e informal taburete sobre ruedas de altura regulable (43/53 cm) mediante pistón a gas, dotado de un característico asiento en forma de silla de montar que favorece una postura ergonómicamente correcta.

Asiento y disquetes cobre-ruedas en polímero técnico con pulsadores de regulación cromados. Estructura en acero cromado.



2265. WELCOME
SGABELLO SU RUOTE
CON ALTEZZA REGOLABILE
STOOL ON CASTORS
WITH ADJUSTABLE HEIGHT
Ø 62 x h 43-53 cm
dia. 24.5" x h 17-20.25"





POPPY

design Raul Barbieri
2010



POPPY

design Raul Barbieri, 2010

Famiglia di eleganti tavolini monocolore in 3 diametri (38, 50 e 60 cm) e 3 altezze (40, 56 e 72 cm). Il tavolino ideale per bar raffinati e sale d'attesa, ma anche al lato del divano di casa, per rilassarsi con un aperitivo leggendo il giornale. Piano in cristallo temperato 8 mm. Gamba in acciaio verniciato. Base in acciaio ricoperto in polimero tecnico.

Family of smart monochrome side tables in 3 diameters (38, 50 and 60 cm) and 3 heights (40, 56 and 72 cm). The ideal coffee-table for refined bars and lounges, but also at the side of the couch at home, for relaxing with a drink whilst reading the newspaper. Tempered crystal top 8 mm. Painted steel frame. Base cover in engineering polymer.

Famille d'élégantes guéridons monochromes en 3 diamètres (38, 50 et 60 cm) et 3 hauteurs (40, 56 et 72 cm). Le guéridon idéal pour bars élégants et salles d'attente, mais aussi à côté du canapé à la maison, pour se détendre avec un apéritif en lisant le journal. Plateau en cristal trempé 8 mm. Pied en acier verni. Couverture de la base en polymère technique.

Familie von stilvollen, einfarbigen Tischen, erhältlich mit drei Durchmesser (38, 50 und 60 cm) und drei Höhen (40, 56 und 72 cm). Der ideale Tisch für stilvolle Bars und Warteräume, aber auch als Couchtisch zu Hause, um beim Lesen der Zeitung den Kaffee abzustellen. Tischplatte aus Hart-Kristallglas 8 mm. Fuß aus lackiertem Stahl. Stahlsockel mit Technischem-Polymer Abdeckung.

Familia de elegantes mesitas monocolor disponibles en 3 diámetros (38, 50 y 60 cm) y 3 alturas (40, 56 y 72 cm). La mesita ideal para bares refinados y salas de espera, pero también para colocar junto al sofá de casa, para relajarse con un aperitivo mientras se lee el periódico. Tapa en cristal templado 8 mm. Estructura en acero pintado. Cobertura de la base en polímero técnico.

2101-2. POPPY

TAVOLINO

SIDE TABLE

2101. Ø 38 x h 40 cm
dia. 15" x 15.75"

2102. Ø 38 x h 56 cm
dia. 15" x 22"

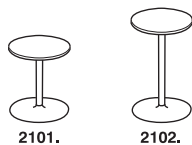

2105-6-7. POPPY

TAVOLINO

SIDE TABLE

2105. Ø 50 x h 40 cm
dia. 19.75" x 15.75"

2106. Ø 50 x h 56 cm
dia. 19.75" x 22"

2107. Ø 50 x h 72 cm
dia. 19.75" x 28.25"

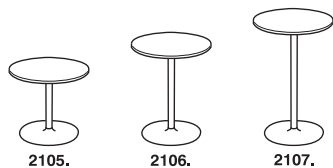

2108-9-10. POPPY

TAVOLINO

SIDE TABLE

2108. Ø 60 x h 40 cm
dia. 23.5" x 15.75"

2109. Ø 60 x h 56 cm
dia. 23.5" x 22"

2110. Ø 60 x h 72 cm
dia. 23.5" x 28.25"

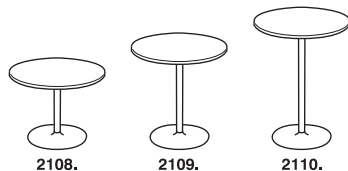



70

DESCO

design Raul Barbieri
2005



DESCO

design Raul Barbieri, 2005

Tavolino con struttura in acciaio inossidabile satinato e piano in cristallo che ne mette in risalto la linea pura e rigorosa. Piano diametro 60 cm; due altezze, 45 e 75 cm.

Struttura in acciaio inossidabile satinato. Piano in cristallo temperato 8 mm, trasparente, opaco, fumé.

Side table with brushed stainless steel frame and a crystal top that highlights its pure, rigorous lines. Top diameter 60 cm; two heights, 45 and 75 cm.

Brushed stainless steel frame. Tempered crystal top 8 mm, transparent, matt, smoky.

Guéridon avec structure en acier inoxydable satiné et plateau en cristal accentuant sa ligne pure et rigoureuse. Plateau diamètre 60 cm; deux hauteurs, 45 et 75 cm.

Structure en acier inoxydable satiné. Plateau en cristal trempé 8 mm, transparent, dépoli ou fumé.

Beistelltisch mit Gestell aus satiniertem Edelstahl und einer Kristallglasplatte, die die klare und strenge Linienführung noch weiter hervorhebt. Tischplatte mit 60 cm Durchmesser; zwei Höhen, 45 und 75 cm.

Gestell aus satiniertem Edelstahl. Tischplatte aus Hart-Kristallglas 8 mm, transparent, matt, rauchfarbig.

Mesita con estructura de acero inoxidable satinado y tapa en cristal que resaltan la línea pura y rigurosa. Tapa diámetro 60 cm; dos alturas, 45 y 75 cm.

Estructura en acero inoxidable satinado. Tablero en cristal templado 8 mm, transparente, matizado, fumé.

**2129-31, DESCO**TAVOLINO
SIDE TABLE

2129. Ø 60 x h 45 cm
dia. 23.5" x 17.75"

2131. Ø 60 x h 75 cm
dia. 23.5" x 29.5"

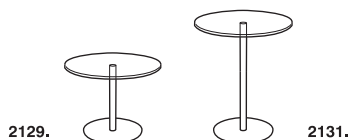



WOODY

design Raul Barbieri
2016



WOODY

design Raul Barbieri, 2016

Famiglia di tavolini con gambe in faggio e piani in MDF laccato antigraffio, ideali punti di ritrovo per le sedie Olivia Wood ma, grazie al loro carattere informale, adatti anche ai più vari abbinamenti. Woody è disponibile in 3 diametri (60, 75 e 90 cm) e 3 altezze (45, 60 e 74 cm).

Piani in MDF 20 mm laccato antigraffio. Gambe in legno di faggio massello tornito.

Family of tables with beechwood legs and tops in scratch resistant lacquered MDF, they are the ideal complimentary piece for the Olivia Wood chairs but, thanks to their informal nature, are also suitable for even the most varied combinations. Woody is available in 3 diameters (60, 75 and 90 cm) and 3 heights (45, 60 and 74 cm).

Tops in scratch resistant lacquered 20 mm MDF. Legs in solid turned beechwood.

Famille de petites tables avec pieds en hêtre et plateaux en MDF laqué anti-rayures, point de rencontre idéal pour les chaises Olivia Wood, mais, grâce à leur caractère informel, aussi adaptés aux combinaisons les plus variées. Woody est disponible en 3 diamètres (60, 75 et 90 cm) et 3 hauteurs (45, 60 et 74 cm).

Plateaux en MDF 20 mm laqués anti-rayures. Pieds en bois de hêtre massif tourné.

Familie von Tischen mit Beinen aus Buchenholz und Tischplatten aus kratzfest lackiertem MDF, die ideal zu den Olivia Wood-Stühlen passen, aber dank ihres informellen Charakters auch perfekt mit verschiedenen anderen Möbel Kombinationen. Woody ist erhältlich mit drei Durchmesser (60, 75 und 90 cm) und drei Höhen (45, 60 und 74 cm).

Tischplatten aus kratzfest lackiertem MDF 20 mm. Beine aus massivem gedrehtem Buchenholz.

Familia de mesitas con patas en madera de haya y tapas en MDF lacado anti-arañazos. Puntos de encuentro ideales para las sillas Olivia Wood, gracias a su carácter informal, se prestan también para todo tipo de combinaciones. Woody está disponible en 3 diámetros (60, 75 y 90 cm) y 3 alturas (45, 60 y 74 cm).

Tapa en MDF 20 mm lacado anti-arañazos. Patas torneadas en madera de haya maciza.

2121. WOODY
TAVOLINO
SIDE TABLE
Ø 60 x h 45 cm
dia. 23.5" x 17.5"



2122. WOODY
TAVOLINO
SIDE TABLE
Ø 75 x h 60 cm
dia. 29.25" x 23.5"



2123. WOODY
TAVOLO
TABLE
Ø 90 x h 74 cm
dia. 35.25" x 29"





78

ZANZIPLANO

design Raul Barbieri

2002

AWARDS

I.D. MAGAZINE (Design Distinction)
2003 – New York, U.S.A.

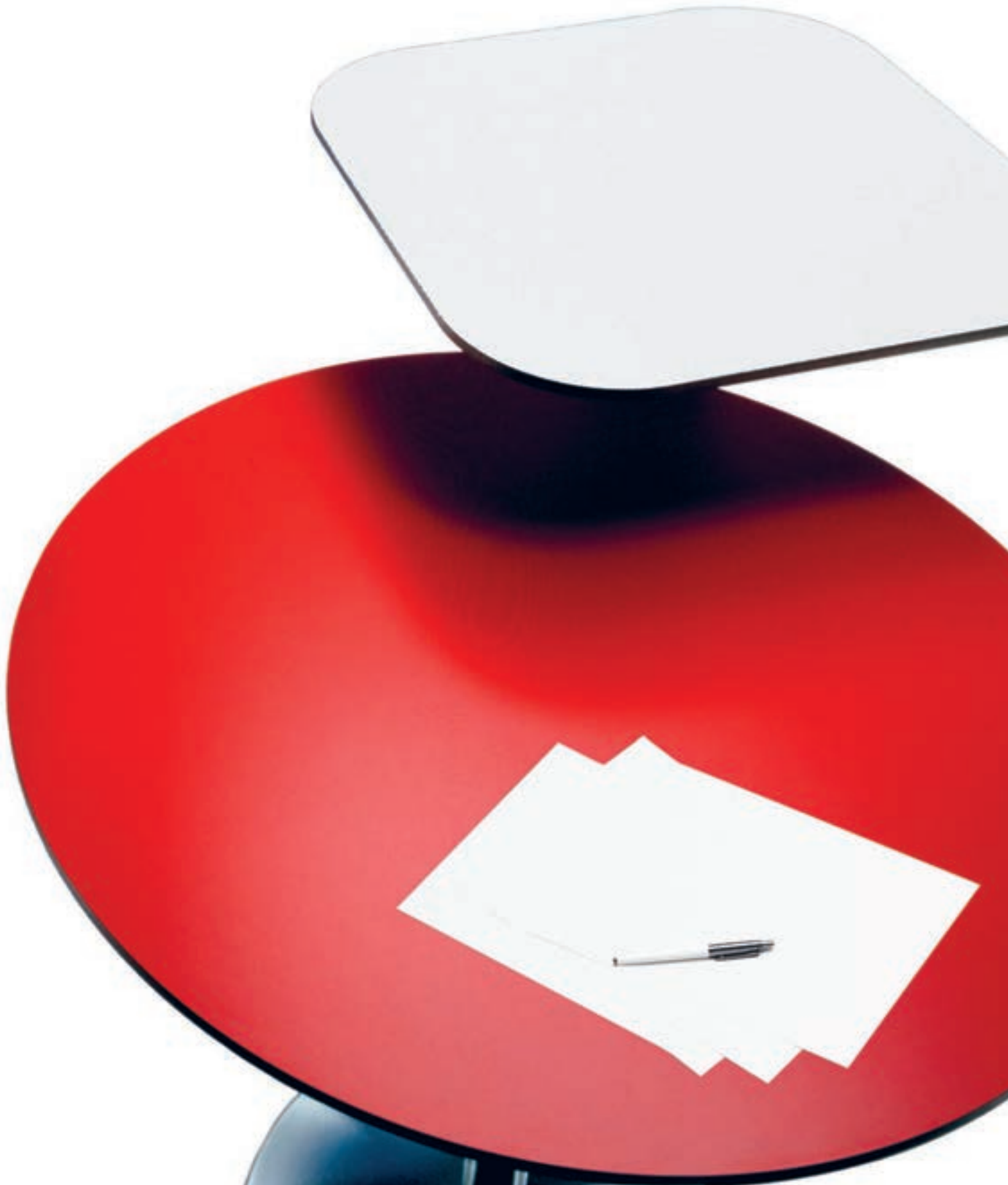

ZANZIPLANO

design Raul Barbieri, 2002

Famiglia di tavoli e tavolini eleganti, versatili ed eccezionalmente robusti, perfetti per bar, aree break aziendali e per spazi pubblici, ma anche per la casa. Zanziplano è disponibile in due altezze, 75 e 105 cm, con piani diametro 60, 90, 120 cm oppure 60x60 e 80x80 cm.

Struttura in acciaio cromato. Piano in stratificato melaminico antigraffio HPL 12 mm. Cono in polimero tecnico nello stesso colore del piano.

A family of elegant, versatile and exceptionally robust tables and coffee tables, perfect for bars, corporate break rooms and communal spaces, but also for the home. Zanziplano is available in two heights, 75 and 105 cm, with tops diameter 60, 90, 120 cm or 60x60 and 80x80 cm.

Chromium plated steel frame. Tops in scratch-resistant high pressure melamine laminate HPL 12 mm. Engineering polymer cone in the same colour as the top.

Famille d'élégants guéridons et tables, polyvalents et exceptionnellement robustes, idéaux aussi bien pour les bars, les espaces pause des entreprises et les espaces publics que pour la maison. Zanziplano est disponible en deux hauteurs, 75 et 105 cm, avec plateaux en diamètres 60, 90, 120 cm ou 60x60 et 80x80cm.

Structure en acier chromé. Plateau en stratifié mélaminique anti-rayures HPL 12 mm. Cône en polymère technique dans la même couleur que le plateau.

Eine Produktfamilie eleganter, vielseitiger und äußerst robuster Tische und Beistelltische, ideal für Bars, Kaffeeküchen in Unternehmen und öffentliche Räume, aber auch für zu Hause. Zanziplano ist in zwei Höhen, 75 und 105 cm, mit Tischplatte 60, 90, 120 cm Durchmesser, oder 60x60 und 80x80 cm erhältlich. Gestell aus verchromtem Stahl. Tischplatte aus kratzfestem Hochdruck-Schichtpreßstoff HPL 12 mm. Kegel aus Technischem-Polymer in gleicher Farbe der Tischplatte.

Familia de elegantes mesas y mesitas, versátiles y extraordinariamente robustas, perfectas para bares, zonas break empresariales y espacios públicos, así como para el hogar. Zanziplano está disponible en dos alturas, 75 y 105 cm, con tapas diámetro 60, 90, 120 cm o 60x60 y 80x80 cm.

Estructura en acero cromado. Tapa en compacto melaminico anti-arañazos HPL 12 mm. Cono en polímero técnico del mismo color de la tapa.



2241-2. ZANZIPLANO TAVOLINO QUADRATO SQUARE COFFEE TABLE

2241.
60 x 60 x h 75 cm
23.5" x 23.5" x h 29.5"

2242.
60 x 60 x h 105 cm
23.5" x 23.5" x h 41.25"



2245-6. ZANZIPLANO TAVOLO QUADRATO SQUARE TABLE

2245.
80 x 80 x h 75 cm
31" x 31" x h 29.5"

2246.
80 x 80 x h 105 cm
31" x 31" x h 41.25"





- 2239-40. ZANZIPLANO**
TAVOLINO ROTONDO
ROUND COFFEE TABLE
- 2239.**
Ø 60 x h 75 cm
dia. 23.5" x h 29.5"
- 2240.**
Ø 60 x h 105 cm
dia. 23.5" x h 41.25"
- 2250-1. ZANZIPLANO**
TAVOLO ROTONDO
ROUND TABLE
- 2250.**
Ø 90 x h 75 cm
dia. 35.5" x h 29.5"
- 2251.**
Ø 90 x h 105 cm
dia. 35.5" x h 41.25"
- 2256. ZANZIPLANO**
TAVOLO ROTONDO
ROUND TABLE
- Ø 120 x h 75 cm
dia. 47.25" x h 29.5"









86

FILIPPO

design Raul Barbieri
2011





FILIPPO

design Raul Barbieri, 2011

Famiglia di tavoli ispirati alla massima semplicità. Robusti e leggeri, si inseriscono con grande naturalezza sia in casa come in ufficio, perfetti per ogni tipo di attività quotidiana. Struttura in acciaio cromato. Piano in stratificato melaminico antigraffio HPL 12 mm.

Family of tables inspired by maximum simplicity. Strong and lightweight, they fit very naturally into both the home or the office and are perfect for any type of daily activity. Chromium plated steel frame. Top in scratch-resistant high pressure melamine laminate HPL 12 mm.

Famille de tables inspirées par une extrême simplicité. Robustes et légères, elles s'intègrent tout naturellement à la maison comme au bureau, idéales pour tout type d'activité quotidienne. Structure en acier chromé. Plateau en stratifié mélaminique anti-rayures HPL 12 mm.

Familie von Tischen durch maximal Einfachheit inspiriert. Robust und leicht, lassen sie sich auf natürliche Weise zu Hause und im Büro in jede Art von täglichen Aktivitäten integrieren. Gestell aus verchromtem Stahl. Tischplatte aus kratzfestem Hochdruck-Schichtpreßstoff HPL 12 mm.

Familia de mesas inspiradas a la máxima simplicidad. Robustas y ligeras, encajan de manera natural tanto en el hogar como en la oficina, y resultan perfectas para cualquier tipo de actividad cotidiana. Estructura en acero cromado. Tapa en compacto melamínico anti-arañazos HPL 12 mm.



2050. FILIPPO
TAVOLO QUADRATO
SQUARE TABLE
79 x 79 x h 74 cm
31" x 31" x h 29"



2052-4. FILIPPO
TAVOLO RETTANGOLARE
RECTANGULAR TABLE
2052. 120 x 79 x h 74 cm
47.25" x 31" x h 29"
2054. 160 x 79 x h 74 cm
63" x 31" x h 29"

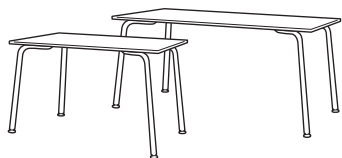

2052.

2054.







ENRICO X

design Alberto Basaglia – Natalia Rota Nodari
2007





ENRICO X

design Alberto Basaglia – Natalia Rota Nodari, 2007

Famiglia di tavoli caratterizzati da una struttura in alluminio che contiene elegantemente il piano del tavolo nel proprio profilo. Quadrati o rettangolari di varie dimensioni, si integrano alla perfezione in ogni tipo di ambiente, sia aziendale che domestico. Struttura in alluminio lucidato. Piano in cristallo temperato 10 mm, opaco o bianco.

Family of tables featuring an aluminium frame that elegantly holds the table top within its profile. Square or rectangular in different sizes, they integrate seamlessly into any environment, whether corporate or domestic. Polished aluminium frame. Tempered crystal top 10 mm, matt or white.

Famille de tables caractérisées par une structure en aluminium qui intègre avec élégance le plateau dans son profil. De forme carrée ou rectangulaire dans diverses tailles, elles s'intègrent à la perfection dans toutes les ambiances, dans les entreprises et à la maison. Structure en aluminium poli. Plateau en cristal trempé 10 mm, dépoli ou blanc.

Familie von Tischen, die durch ihr Aluminium Gestell auffallen, das die Tischplatte auf elegante Weise in das eigene Profil integriert. Die verschiedenen quadratischen oder rechteckigen Größen lassen sich perfekt in jedes Umfeld integrieren, ob im Unternehmen oder zu Hause. Gestell aus poliertem Aluminium. Tischplatte aus Hart-Kristallglas 10 mm, matt oder weiß.

Familia de mesas caracterizadas por una estructura en aluminio que incluye de manera elegante el tablero de la mesa en su propio perfil. Cuadradas o rectangulares, de diferentes tamaños, encajan a la perfección en cualquier tipo de entorno, tanto empresarial como doméstico. Estructura en aluminio pulido. Tapa en cristal templado 10 mm, matizado o blanco.

2070. ENRICO X
TAVOLO QUADRATO
SQUARE TABLE
135 x 135 x h 73,5 cm
53" x 53" x h 29"



2072-4-6. ENRICO X
TAVOLO RETTANGOLARE
RECTANGULAR TABLE
2072. 120 x 85 x h 73,5 cm
47,25" x 33,5" x h 29"
2074. 160 x 85 x h 73,5 cm
63" x 33,5" x h 29"
2076. 180 x 85 x h 73,5 cm
71" x 33,5" x h 29"

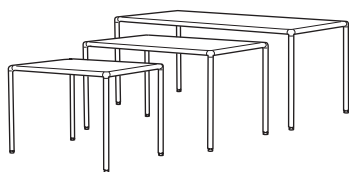

2072.

2074.

2076.









CONVITO

design Raul Barbieri
2005



AWARDS

INTERIOR INNOVATION
2006 – Köln, GERMANY

THE CHICAGO ATHENAEUM
2006 – Chicago, U.S.A.



CONVITO

design Raul Barbieri, 2005

Famiglia di tavoli caratterizzati dalla robusta struttura in acciaio inossidabile che dona un'impronta decisa di forte impatto, sia nel formato rotondo e quadrato che nelle diverse misure rettangolari.

Struttura in acciaio inossidabile satinato. Piano in cristallo temperato 12 mm, trasparente o opaco.

Family of tables featuring a robust base in stainless steel, making a high-impact mark, both in its round and square formats as well as the different rectangular dimensions.

Brushed stainless steel base. Tempered crystal top 12 mm, matt or transparent.

Famille de tables caractérisées par une structure robuste en acier inoxydable qui donne une impression forte de grand impact, dans des formes rondes, carrées et dans différentes dimensions rectangulaires.

Structure en acier inoxydable satiné. Plateau en cristal trempé 12 mm, transparent ou dépoli.

Familie von Tischen mit robustem Edelstahl Gestell, das einen entschiedenen Eindruck hinterlässt. Erhältlich sowohl rund, als auch quadratisch und in verschiedenen rechteckigen Größen. Gestell aus satiniertem Edelstahl. Tischplatte aus Hart-Kristallglas 12 mm, transparent oder matt.

Familia de mesas caracterizadas por una robusta estructura de acero inoxidable que les confiere un carácter decidido de fuerte impacto, tanto en el formato redondo o cuadrado como en los diferentes tamaños rectangulares.

Estructura en acero inoxidable satinado. Tapa en cristal templado 12 mm, transparente o matizado.

2138. CONVITO
TAVOLO ROTONDO
ROUND TABLE
Ø 135 x h 75 cm
dia. 53" x 29.5"



2140. CONVITO
TAVOLO QUADRATO
SQUARE TABLE
140 x 140 x h 75 cm
55" x 55" x 29.5"



2142-4-8. CONVITO
TAVOLO RETTANGOLARE
RECTANGULAR TABLE

2142. 160 x 80 x h 75 cm
63" x 31" x 29.5"

2144. 200 x 95 x h 75 cm
78.75" x 37.5" x 29.5"

2148. 225 x 140 x h 75 cm
87.75" x 55" x 29.5"

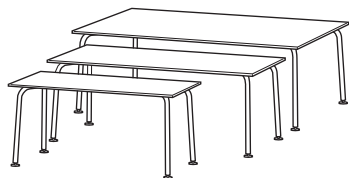

2142. 2144. 2148.









104

ALEX

design Raul Barbieri
2007





ALEX

design Raul Barbieri, 2007

Raffinata famiglia di tavoli con struttura in fusione di alluminio che ripropone la linea agile ed elegante della sedia Alexa e aggiunge un tocco di grande classe a ogni tipo di ambiente. Struttura in fusione di alluminio lucidata o cromata. Piano in cristallo temperato 12 mm, trasparente o opaco.

Sophisticated family of tables with base in aluminium casting that represents the agile, elegant line of the Alexa chair and adds a significant touch of class to every environment. Base in polished or chromium plated aluminium casting. Tempered crystal top 12 mm, matt or transparent.

Famille de tables raffinées avec structure en fusion d'aluminium qui rappelle la ligne agile et élégante de la chaise Alexa et ajoute une touche de grande classe à tout ambiance. Structure en fusion d'aluminium poli ou chromé. Plateau en cristal trempé 12 mm, transparent ou dépoli.

Raffinierte Familie von Tischen mit Aluminiumguß Gestell, die die elegante und agile Linienführung des Alexa-Stuhls wieder aufnimmt, und jeder Umgebung einen Hauch von Klasse verleiht. Gestell aus poliertem oder verchromtem Aluminiumguß. Tischplatte aus Hart-Kristallglas 12 mm, transparent oder matt.

Refinada familia de mesas con estructura en fusión de aluminio, que propone de nuevo la línea ágil y elegante de la silla Alexa y que otorga un toque distinguido a cualquier tipo de ambiente. Estructura en fusión de aluminio, pulido o cromado. Tapa en cristal templado 12 mm, transparente o matizado.

2150. ALEX
TAVOLO QUADRATO
SQUARE TABLE
160 x 160 x h 75 cm
63" x 63" x h 29.5"



2152-4-8. ALEX
TAVOLO RETTANGOLARE
RECTANGULAR TABLE

2152. 140 x 90 x h 75 cm
55" x 35.5" x h 29.5"

2154. 170 x 90 x h 75 cm
67" x 35.5" x h 29.5"

2158. 230 x 100 x h 75 cm
90.5" x 39.5" x h 29.5"



2152. 2154. 2158.









NOX COLLECTION

design Raul Barbieri

2002

AWARDS

NOX

CONTRACT DESIGN

2002 – Genova, ITALY

NOX MAGNUM

ARCHITEKTUR UND OFFICE (Innovationspreis)

2004 – Köln, GERMANY

19th BIENNIAL OF INDUSTRIAL DESIGN

2004 – Ljubljana, SLOVENIA



NOX

design Raul Barbieri, 2002

Una collezione di contenitori caratterizzati dalla linea classica e dal prestigio dell'acciaio inossidabile: cestini gettacarte, cestini alti, portaombrelli e posacenere da terra. I cestini possono essere equipaggiati con un supporto interno per sacchetti e con un pratico coperchio antifiamma.

Acciaio inossidabile AISI 304 0,8 mm satinato. Linea di giunzione con saldatura invisibile, bordi arrotondati antinfortunio. Guarnizione salva-pavimento in gomma.

Collection of containers featuring a classic design and the prestige of stainless steel: waste baskets, tall baskets, umbrella stands and floor ashtrays. The baskets can be equipped with internal bag holder and with a practical anti-flame lid.

Brushed stainless steel AISI 304 0.8 mm. Connecting line with invisible welding seam, safety rounded edges. Rubber floor-protection seal.

Une collection de conteneurs caractérisée par le design minimaliste et le prestige de l'acier inoxydable: corbeilles à papier, corbeilles haute, porte-parapluies et cendriers de sol. Les corbeilles à papier sont équipables d'un support interne pour sacs et d'un pratique couvercle anti-flamme.

Acier inoxydable AISI 304 0,8 mm satiné. Ligne de jonction avec soudure invisible, bords arrondis non coupants. Garniture protège-sol en caoutchouc.

Eine Kollektion von Behälter, die durch ihre klassische Linie und dem ansehnlichen Edelstahl gekennzeichnet ist: Papierkörbe, hohe Körbe, Schirmständer und Standaschenbecher. Die Papierkörbe können mit einer internen Abfallsack-Halterung und einem praktischen Brandschutzdeckel ausgestattet werden. Satinierter Edelstahl AISI 304 0,8 mm. Verbindungslinie mit unsichtbare Schweißnaht, unfallsichere abgerundete Ränder. Gummierter Fußbodenschutz.

Colección de contenedores caracterizados por el diseño clásico y el prestigio del acero inoxidable: papeleras, papeleras altas, paragüeros y ceniceros de pie. Las papeleras pueden ser equipadas con un soporte interno para bolsas y con una práctica tapa anti-llama.

Acero inoxidable AISI 304 0,8 mm satinado. Línea de unión con soldadura invisible, bordes redondeados de seguridad. Protector de suelo en goma.

1600-01-03. NOX

1600. CESTINO ALTO / PORTAOMBRELLI
TALL BASKET / UMBRELLA STAND

1601. CON PORTASACCHETTI
WITH BAG HOLDER

1603. CON PORTASACCHETTI
E COPERCHIO ANTIFIAMMA
WITH BAG HOLDER, ANTI-FLAME LID

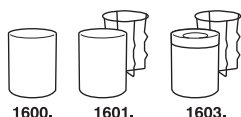

Ø 28 x h 35 cm (21 litri/litres)
dia. 11" x h 13.75" (5.5 gallons)

1610-11-09. NOX

1610. CESTINO ALTO / PORTAOMBRELLI
TALL BASKET / UMBRELLA STAND

1611. CON PORTASACCHETTI
WITH BAG HOLDER

1609. CON PORTASACCHETTI
E COPERCHIO ANTIFIAMMA
WITH BAG HOLDER, ANTI-FLAME LID

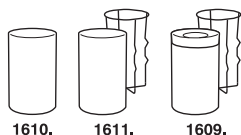

Ø 28 x h 50 cm (30 litri/litres)
dia. 11" x h 19.75" (8 gallons)

42. NOX
COPERCHIO ANTIFIAMMA
ANTI-FLAME LID



Ø 28,5 x h 4 – foro/hole Ø 14 cm
dia. 11.25" x h 1.5" – hole dia. 5.5"

38. NOX / NOX MAGNUM
KIT DI COLLEGAMENTO
CONNECTING KIT



Ø 3,2 x 6 cm
dia. 1.25" x 2.25"





NOX

design Raul Barbieri, 2002

I posacenere da terra Nox sono disponibili sia nella semplice versione a stelo, che nella versione abbinata al cestino gettacarte alto.

Acciaio inossidabile AISI 304 0,8 mm satinato. Linea di giunzione con saldatura invisibile, bordi arrotondati antinfortunistico. Guarnizione salva-pavimento in gomma.

The Nox floor ashtrays are available in the simple stem version as well as in the combined version with tall waste basket.

Brushed stainless steel AISI 304 0.8 mm. Connecting line with invisible welding seam, safety rounded edges. Rubber floor-protection seal.

Les cendriers de sol Nox sont disponibles soit dans une version simple sur pied, soit dans une version combinée avec une corbeille à papier haute.

Acier inoxydable AISI 304 0,8 mm satiné. Ligne de jonction avec soudure invisible, bords arrondis non coupants. Garniture protège-sol en caoutchouc.

Die Standaschenbecher Nox sind erhältlich in der einfachen Version mit Ständer oder in Kombination mit einem Papierkorb. Satiniertes Edelstahl AISI 304 0,8 mm. Verbindungslinie mit unsichtbare Schweißnaht, unfallsichere abgerundete Ränder. Gummierter Fußbodenschutz.

Los ceniceros de pie Nox están disponibles tanto en la versión básica como en la versión integrada en una papelera alta.

Aceros inoxidable AISI 304 0,8 mm satinado. Línea de unión con soldadura invisible, bordes redondeados de seguridad. Protector de suelo en goma.

1613-5. NOX
POSACENERE DA TERRA CON CESTINO
FLOOR ASHTRAY WITH WASTE BASKET

1613. CON VASCETTA
WITH CUP

1615. CON COPERCHIO AD ANELLO
WITH COVER RING

Ø 28 x h 76 cm (30 litri/litres)
dia. 11" x h 30" (8 gallons)

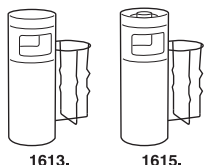

1613.

1615.

1620-2. NOX
POSACENERE DA TERRA
FLOOR ASHTRAY

1620. CON VASCETTA
WITH CUP

1622. CON COPERCHIO AD ANELLO
WITH COVER RING

Ø 28 x h 76 cm
dia. 11" x h 30"

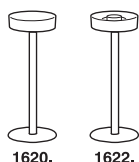

1620.

1622.





NOX MAGNUM

design Raul Barbieri, 2004

Contenitore king-size da 70 litri, alto 64 cm, diametro 38 cm. Può essere attrezzato sia con un supporto interno per sacchetti, che con un pratico coperchio antifiamma o un elegante coperchio basculante.

Acciaio inossidabile AISI 304 0,8 mm satinato. Linea di giunzione con saldatura invisibile, bordi arrotondati antinfortunio. Guarnizione salva-pavimento in gomma.

King-size 70 litre container, 64 cm high, 38 cm diameter. It can be fitted with both an internal bag holder and a smart anti-flame lid or an elegant flip top lid.

Brushed stainless steel AISI 304 0.8 mm. Connecting line with invisible welding seam, safety rounded edges. Rubber floor-protection seal.

Maxi conteneur de 70 litres, hauteur 64 cm, diamètre 38 cm. Il peut être équipé soit d'un support interne pour sacs, et d'un pratique couvercle anti-flamme ou bien d'un élégant couvercle basculant.

Acier inoxydable AISI 304 0,8 mm satiné. Ligne de jonction avec soudure invisible, bords arrondis non coupants. Garniture protège-sol en caoutchouc.

Kingsize 70-Liter-Behälter, 64 cm hoch, 38 cm Durchmesser. Kann mit einer internen Abfallsack-Halterung und mit einem praktischen Brandschutzdeckel oder mit einem eleganten Schwingdeckel ausgestattet werden.

Satinierter Edelstahl AISI 304 0,8 mm. Verbindungslinie mit unsichtbare Schweißnaht, unfallsichere abgerundete Ränder. Gummierter Fußbodenschutz.

Contenedor extra grande de 70 litros, altura 64 cm, diámetro 38 cm. Puede ser equipado con un soporte interno para bolsas y con una práctica tapa anti-llama o una elegante tapa basculante.

Acero inoxidable AISI 304 0,8 mm satinado. Línea de unión con soldadura invisible, bordes redondeados de seguridad. Protector de suelo en goma.



1665-6-7-8. NOX MAGNUM

1665. CONTENITORE
CONTAINER

1666. CON PORTASACCHETTI
WITH BAG HOLDER

1668. CON PORTASACCHETTI
E COPERCHIO ANTIFIAMMA
WITH BAG HOLDER
AND ANTI-FLAME LID

Ø 38 x h 64 cm (70 litri/litres)
dia. 15" x h 25" (18,5 gallons)

1667. CON PORTASACCHETTI
E COPERCHIO BASCULANTE
WITH BAG HOLDER
AND FLIP TOP LID

Ø 38 x h 76 cm (70 litri/litres)
dia. 15" x h 30" (18,5 gallons)

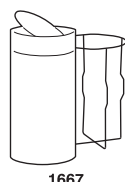
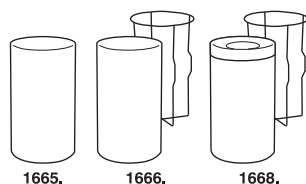

43. NOX MAGNUM
COPERCHIO ANTIFIAMMA
ANTI-FLAME LID

Ø 38,5 x h 4 – foro/hole Ø 18 cm
dia. 15,25" x h 1,5" – hole dia. 7"



38. NOX / NOX MAGNUM
KIT DI COLLEGAMENTO
CONNECTING KIT

Ø 3,2 x 6 cm
dia. 1,25" x 2,25"

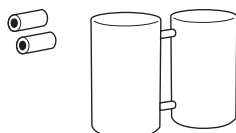







NOX FLORA

design Raul Barbieri, 2004

Fioriere su ruote completamente realizzate in acciaio inossidabile, dotate di un pratico sottovaso interno in polipropilene. Eccezionalmente robuste ed eleganti, sono disponibili in 3 misure, ideali per reception e spazi collettivi.

Acciaio inossidabile AISI 304 0,8 mm satinato. Linea di giunzione con saldatura invisibile, bordi arrotondati antinfortunio. Sottovaso interno in polipropilene.

Planters on castors entirely made in stainless steel, fitted with a practical internal polypropylene saucer. Exceptionally strong and stylish, available in 3 sizes, ideal for reception and communal areas.

Brushed stainless steel AISI 304 0.8 mm. Connecting line with invisible welding seam, safety rounded edges. Internal saucer in polypropylene.

Cache-pots sur roulettes entièrement en acier inoxydable, équipé d'une pratique sous-vase interne en polypropylène. Exceptionnellement robustes et élégants, disponibles en 3 tailles, parfaits pour espaces de réception et collectifs.

Acier inoxydable AISI 304 0,8 mm satiné. Ligne de jonction avec soudure invisible, bords arrondis non coupants. Sous-vase en polypropylène.

Blumenwannen auf Rollen, vollständig aus Edelstahl gefertigt, mit einem praktischen inneren Unterteller aus Polypropylen. Außergewöhnlich robust und elegant, in 3 Größen erhältlich, ideal für die Rezeption und öffentliche Bereiche.

Satinierter Edelstahl AISI 304 0,8 mm. Verbindungslinie mit unsichtbare Schweißnaht, unfallsichere abgerundete Ränder. Unterteller aus Polypropylen.

Maceteros sobre ruedas fabricados íntegramente en acero inoxidable, dotados de un práctico plato interno en polipropileno. Extraordinariamente robustos y elegantes, están disponibles en 3 tamaños, ideales para recepciones y espacios colectivos. Acero inoxidable AISI 304 0,8 mm satinado. Línea de unión con soldadura invisible, bordes redondeados de seguridad. Plato interno en polipropileno.

1681. NOX FLORA

FIORIERA SU RUOTE

PLANTER ON CASTORS

Ø 38 x h 40 cm (38+2 cm)

dia. 15" x h 15.75" (15"+0.75")

**1686. NOX FLORA**

FIORIERA SU RUOTE

PLANTER ON CASTORS

Ø 52 x h 45 cm (43+2 cm)

dia. 20.5" x h 17.75" (17"+0.75")

**1688. NOX FLORA**

FIORIERA SU RUOTE

PLANTER ON CASTORS

Ø 66 x h 50 cm (48+2 cm)

dia. 26" x h 19.75" (19"+0.75")





NOX WALL

design Raul Barbieri, 2005

Cestini gettacarte e posacenere da parete dotati di fissaggio antifurto, completamente realizzati in acciaio inossidabile. Eleganti, robusti e di facile installazione, sono ideali per banche e spazi pubblici.

Acciaio inossidabile AISI 304 0,8 mm satinato. Linea di giunzione con saldatura invisibile, bordi arrotondati antinfortunio.

Wall waste baskets and ashtrays fitted with anti-theft locking, made entirely in stainless steel. Elegant, solid and easy to install, they are ideal for use in banks and communal spaces.

Brushed stainless steel AISI 304 0.8 mm. Connecting line with invisible welding seam, rounded safety edges.

Corbeilles à papier et cendriers muraux avec fixations anti-vol, entièrement en acier inoxydable. Élégants, robustes et facile à installer, ils sont parfaits pour une utilisation dans banques et espaces publics.

Acier inoxydable AISI 304 0,8 mm satiné. Ligne de jonction avec soudure invisible, bords arrondis non coupants.

Wand-Aschenschale und Wand-Papierkörbe mit Diebstahlsicherung, vollständig aus Edelstahl gefertigt. Elegant, robust und einfach zu installieren, sind ideal für Banken und öffentliche Räume.

Satiniertes Edelstahl AISI 304 0,8 mm. Verbindungslinie mit unsichtbare Schweißnaht, unfallsichere abgerundete Ränder.

Papeleras y ceniceros de pared dotados de fijación antirrobo, fabricados íntegramente en acero inoxidable. Elegantes, robustos y de fácil instalación, son ideales para bancos y espacios públicos.

Acero inoxidable AISI 304 0,8 mm satinado. Línea de unión con soldadura invisible, bordes redondeados de seguridad.

1626. NOX WALL
POSACENERE DA PARETE
WALL ASHTRAY

32 x 16 x h 16 (8+8) cm
12.5" x 6.5" x h 6.5" (3.25"+3.25")



1629. NOX WALL
CESTINO DA PARETE
WALL WASTE BASKET

32 x 16 x h 43 cm (12,5 litri/litres)
12.5" x 6.5" x h 17" (3.25 gallons)



CHANGE →

← BANCOMAT



124

NOX VESTA

design Raul Barbieri

2005



NOX VESTA

design Raul Barbieri, 2005

Appendiabiti a barra su ruote, interamente realizzati in acciaio inossidabile satinato. Solidi ed agili, sono perfetti per hotel, sale conferenze e collettività. Al modello base con semplice barra appendiabiti si affiancano tre modelli dotati anche di supporto inferiore e superiore. Due ruote con freno.

Acciaio inossidabile AISI 304 satinato. Lunghezze 120 e 160 cm.

Coat rails on castors, made entirely in brushed stainless steel. Solid and agile, they are perfect for hotels, conference halls and communities. The basic model with simple coat rail is accompanied by three models fitted with upper and lower support. Two castors with brake.

Brushed stainless steel AISI 304. Lengths 120 and 160 cm.

Porte-manteau à barre sur roulettes, entièrement en acier inoxydable satiné. Solides et légers, ils sont parfaits pour les hôtels, les salles de conférence et les collectivités. Le modèle de base avec une barre à cintres est complété de trois modèles dotés d'un support inférieur et supérieur. Deux roulettes avec freins.

Acier inoxydable AISI 304 satiné. Longueurs 120 et 160 cm.

Kleiderbügelständer auf Rollen, vollständig aus Edelstahl gefertigt. Solide und wendig, sind ideal für Hotels, Konferenzräume und Gemeinschaftsräume. Das Basismodell mit Kleiderstange gibt es auch mit einer oberen und unteren Ablage. Zwei Rollen mit Bremse.

Satinierter Edelstahl AISI 304. Längen 120 und 160 cm.

Percheros de barra sobre ruedas, fabricados íntegramente en acero inoxidable satinado. Sólidos y ágiles, son perfectos para hoteles, salas de conferencias y salas multiusos. Al modelo básico con barra colgador le acompañan otros tres modelos dotados de soporte inferior y superior. Freno en dos ruedas.

Acero inoxidable AISI 304 satinado. Longitudes 120 y 160 cm.

1640. NOX VESTA APPENDIABITI A BARRA SU RUOTE COAT RAIL ON CASTORS

1640.12.
128 x 53 x h 170 cm
50.5" x 20.75" x h 67"

1640.16.
168 x 53 x h 170 cm
66.25" x 20.75" x h 67"

1642. NOX VESTA CON SUPPORTO PER BORSE WITH BOTTOM BAG RACK

1642.12.
128 x 53 x h 170 cm
50.5" x 20.75" x h 67"

1642.16.
168 x 53 x h 170 cm
66.25" x 20.75" x h 67"

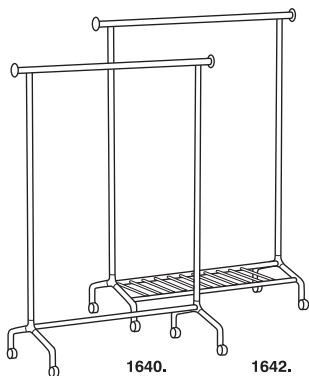

1641. NOX VESTA CON CAPPELLIERA WITH BOTTOM BAG RACK

1641.12.
120 x 53 x h 176 cm
47.25" x 20.75" x h 69.25"

1641.16.
160 x 53 x h 176 cm
63" x 20.75" x h 69.25"

1643. NOX VESTA CON CAPPELLIERA E SUPPORTO PER BORSE WITH HAT AND BAG RACKS

1643.12.
120 x 53 x h 176 cm
47.25" x 20.75" x h 69.25"

1643.16.
160 x 53 x h 176 cm
63" x 20.75" x h 69.25"

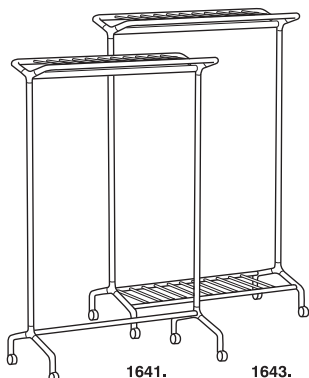







NOX VESTA WALL

design Raul Barbieri, 2005

Appendiabiti da parete interamente in acciaio inossidabile, caratterizzato dal disegno minimalista. Le barre, disponibili in due lunghezze (48 e 96 cm), da 3 e 6 posti, sono accostabili in continuo per composizioni senza limiti.
Acciaio inossidabile AISI 304 satinato.

Stainless steel wall coat-hanger with minimalist design. The bars, available in two lengths (48 and 96 cm), with 3 and 6 spaces, can be continuously combined for unlimited compositions.

Brushed stainless steel AISI 304.

Porte-manteau mural entièrement en acier inoxydable, d'une conception minimaliste. Les barres, disponibles en deux longueurs (48 et 96 cm), de 3 et 6 places, sont assemblables en continu pour compositions illimitées.
Acier inoxydable AISI 304 satiné.

Wand-Kleiderhaken aus Edelstahl mit minimalistischem Design. Die Leisten, in zwei Längen erhältlich (48 und 96 cm), mit 3 oder 6 Aufhängern, können für grenzenlose Kombinationsmöglichkeiten nebeneinander montiert werden.
Satinierter Edelstahl AISI 304.

Perchero de pared fabricado íntegramente en acero inoxidable, caracterizado por un diseño minimalista. Las barras, disponibles en dos longitudes (48 y 96 cm), de 3 y 6 plazas, se pueden colocar de forma continua en composiciones sin límites.
Acero inoxidable AISI 304 satinado.

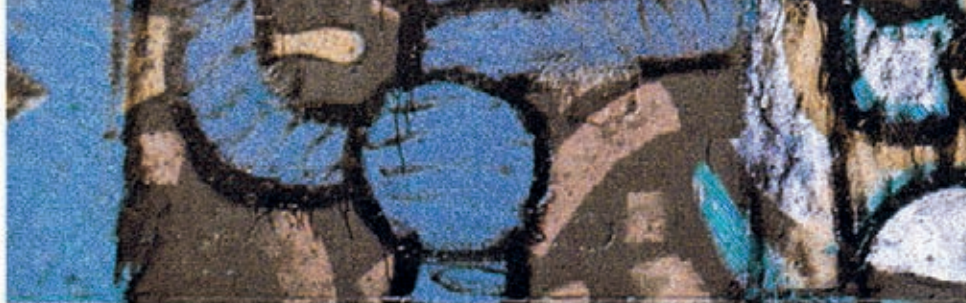

1650. NOX VESTA WALL
APPENDIABITI DA PARETE
WALL COAT HANGER

1650.05. (3 POSTI/SPACES)
48 x 7 x h 7 cm
19" x 2.75" x h 2.75"

1650.10. (6 POSTI/SPACES)
96 x 7 x h 7 cm
37.75" x 2.75" x h 2.75"





132

NOX IPSO

design Raul Barbieri

2005



NOX IPSO

design Raul Barbieri, 2005

La grande purezza del disegno è posta in risalto dalla realizzazione interamente in acciaio inossidabile satinato e dal nucleo centrale in raffinata microfusione da cui si dipartono i 4 bracci, ciascuno dei quali termina in un disco perfetto. Acciaio inossidabile AISI 304 satinato. Guarnizione salvapavimento in poliestere.

The purity of this design is highlighted by the entire manufacturing in brushed stainless steel, with the central core in a refined microcasting from where the 4 arms stick out with perfect discs at the end of each.
Brushed stainless steel AISI 304. Polyester floor-protection seal.

La grande pureté du design est soulignée par sa réalisation entièrement en acier inoxydable satiné, et par le noyau central en microfusion raffinée d'où partent les 4 bras, chacun se terminant par un disque parfait.
Acier inoxydable AISI 304 satiné. Garniture protège-sol en polyester.

Die große Reinheit des Designs wird unterstrichen durch das Gestell, vollständig aus Edelstahl gefertigt. Vom Nukleus aus raffiniertem Mikroguss gehen vier Arme ab, die jeweils mit einer kreisrunden Scheibe abgeschlossen werden.
Satinierter Edelstahl AISI 304. Polyester Fußbodenschutz.

El diseño de gran pureza es resaltado por la fabricación íntegra en acero inoxidable satinado y por el núcleo central de refinada micro-fusión del que parten 4 brazos, cada uno de los cuales termina en un disco perfecto.
Acero inoxidable AISI 304 satinado. Protector de suelo en poliéster.



1635. NOX IPSO
APPENDIABITI
COAT STAND
Ø 41 x h 170 cm
dia. 16,25" x h 67"





136

NOX EGO

design Raul Barbieri
2010



NOX EGO

design Raul Barbieri, 2010

Appendiabiti da terra in acciaio inossidabile satinato, caratterizzato dal disegno minimalista e dalle dimensioni contenute, si inserisce in ogni ambiente con elegante discrezione. Acciaio inossidabile AISI 304 satinato. Guarnizione salvapavimento in poliester.

Kit portaombrelli opzionale in polimero tecnico trasparente.

Stainless steel coat stand with minimalist design and compact size, it fits into any environment with elegant discretion.

Brushed stainless steel AISI 304. Polyester floor-protection seal.

Optional umbrella-stand kit in transparent engineering polymer.

Porte-manteaux sur pied en acier inoxydable satiné. Caractérisé par son design minimaliste et sa taille compacte, il se glisse dans tout environnement avec élégante discrétion.

Acier inoxydable AISI 304 satiné. Garniture protège-sol en polyester.

Kit porte-parapluie optionnel en polymère technique transparent.

Kleiderständer aus satiniertem Edelstahl mit minimalistischem Design. Mit seiner kompakten Größe passt er elegant und diskret in jede Umgebung.

Satinierter Edelstahl AISI 304. Polyester Fußbodenschutz.

Optional Kit-Schirmständer aus transparentem Technischem-Polymer.

Perchero de pie en acero inoxidable satinado, caracterizado por un diseño minimalista y un tamaño compacto que encaja con elegante discreción en cualquier entorno.

Acero inoxidable AISI 304 satinado. Protector de suelo en poliéster.

Kit paraguero opcional en polímero técnico transparente.



1637. NOX EGO
APPENDIABITI
COAT STAND
Ø 29 x h 167,5 cm
dia. 11.5" x h 66"

39.
KIT PORTAOMBRELLI
UMBRELLA STAND KIT
Ø 26,5 cm
dia. 10.5"

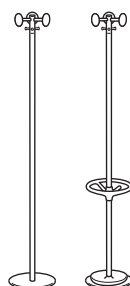



140

ALTER EGO

design Raul Barbieri

2014



ALTER EGO

design Raul Barbieri, 2014

Appendiabiti da terra caratterizzato dal disegno minimalista e dalle dimensioni contenute, che ne consentono il facile inserimento in ogni tipo di ambiente.

Testa, asta e base in acciaio verniciato o cromato. Guarnizione salva-pavimento in poliestere.

Kit portaombrelli opzionale in polimero tecnico.

Coat stand with minimalist design and compact size, it easily fits into any environment.

Head, rod and base in painted or chromed steel. Polyester floor-protection seal.

Optional umbrella-stand kit in engineering polymer.

Porte-manteau sur pied caractérisé par son design minimaliste et sa petite taille permettant de l'intégrer facilement dans tous les environnements.

Tête, tige et base en acier verni ou chromé. Garniture protégé-sol en polyester.

Kit porte-parapluie optionnel en polymère technique.

Kleiderständer mit minimalistischem Design und kompakter Größe, der sich einfach in jede Umgebung integrieren lässt.

Kopf, Stange und Sockel aus lackiertem oder verchromtem Stahl. Polyester Fußbodenschutz.

Optional Kit-Schirmständer aus Technischem-Polymer.

Perchero de pie caracterizado por un diseño minimalista y un tamaño compacto, lo que permite integrarlo fácilmente en cualquier tipo de ambiente.

Cabeza, barra y base en acero pintado o cromado. Protector de suelo en poliéster.

Kit paraguero opcional en polímero técnico.

**1040. ALTER EGO**

APPENDIABITI

COAT STAND

Ø 35 x h 167,5 cm
dia. 13,75" x h 66"

39.

KIT PORTAOMBRELLI

UMBRELLA STAND KIT

Ø 26,5 cm
dia. 10,5"

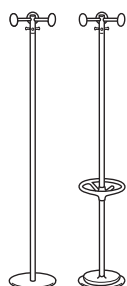



144

AIUTO

design Raul Barbieri – Giorgio Marianelli
1982

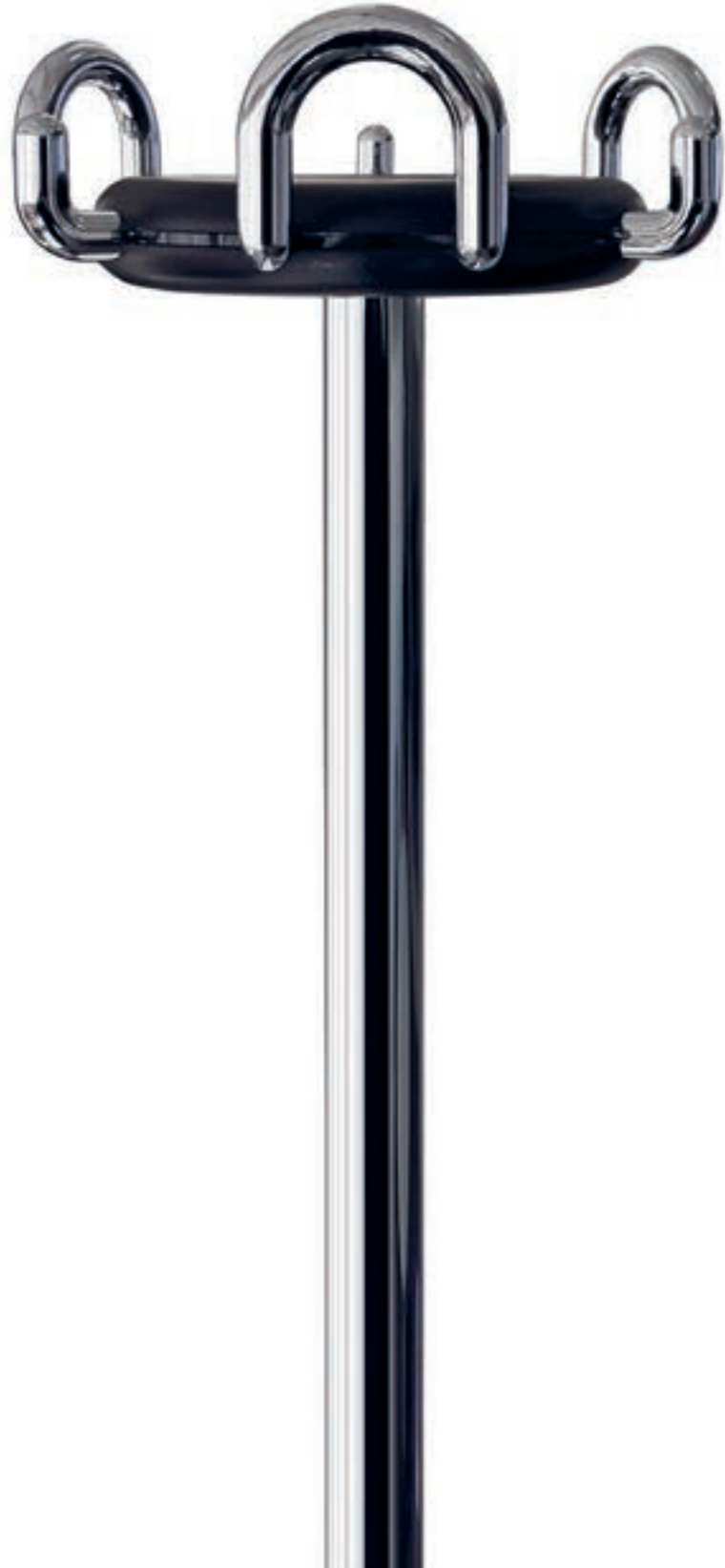

AIUTO

design Raul Barbieri – Giorgio Marianelli, 1982

Storico appendiabiti da terra ancora oggi più che mai attuale, grazie suo al disegno rigoroso ma garbato che ne ha fatto uno dei più longevi best seller presenti sul mercato.

Testa e ganci in polimero tecnico, asta in acciaio verniciato o cromato. Base in acciaio ricoperta in polimero tecnico.

Guarnizione salva pavimento in poliestere.

Kit portaombrelli opzionale in polimero tecnico.

Historical coat stand and even more modern today, thanks to its unyielding yet graceful design that has made it one of the longest running best sellers on the market.

Engineering polymer head and hooks, rod in painted or chromed steel. Steel base with engineering polymer cover. Polyester floor-protection seal.

Optional umbrella-stand kit in engineering polymer.

Historique porte-manteau sur pied plus actuel aujourd'hui que jamais, grâce à son design rigoureux mais doux, qui fait de lui l'un des plus anciens best-sellers sur le marché.

Tête et patères en polymère technique, tige en acier verni ou chromé. Base en acier avec couverture en polymère technique. Garniture protège-sol en polyester.

Kit porte-parapluie optionnel en polymère technique.

Historischer Kleiderständer, der heute dank seines rigorosen aber kunstvollen Designs aktueller denn je ist. Einer der langlebigsten Bestseller auf dem Markt.

Kopf und Haken aus technischem Polymer, Stange aus lackiertem oder verchromtem Stahl. Stahlsockel mit Technischem-Polymer Abdeckung. Polyester Fußbodenschutz.

Optional Kit-Schirmständer aus Technischem-Polymer.

Histórico perchero de pie, hoy más actual que nunca, gracias a un diseño riguroso pero amable que lo ha convertido en uno de los éxitos de ventas de mayor recorrido del mercado.

Cabeza y ganchos en polímero técnico, barra de acero pintado o cromado. Base en acero con cubierta en polímero técnico. Protector de suelo en poliéster.

Kit paraguero opcional en polímero técnico.



999. AIUTO
APPENDIABITI
COAT STAND
Ø 36 x h 165 cm
dia. 14.25" x h 65"

19.
KIT PORTAOMBRELLI
UMBRELLA STAND KIT
Ø 26 cm
dia. 10.25"

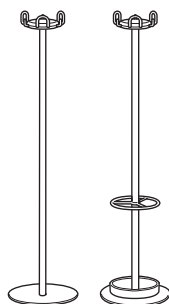



148

POP

design Raul Barbieri
2008

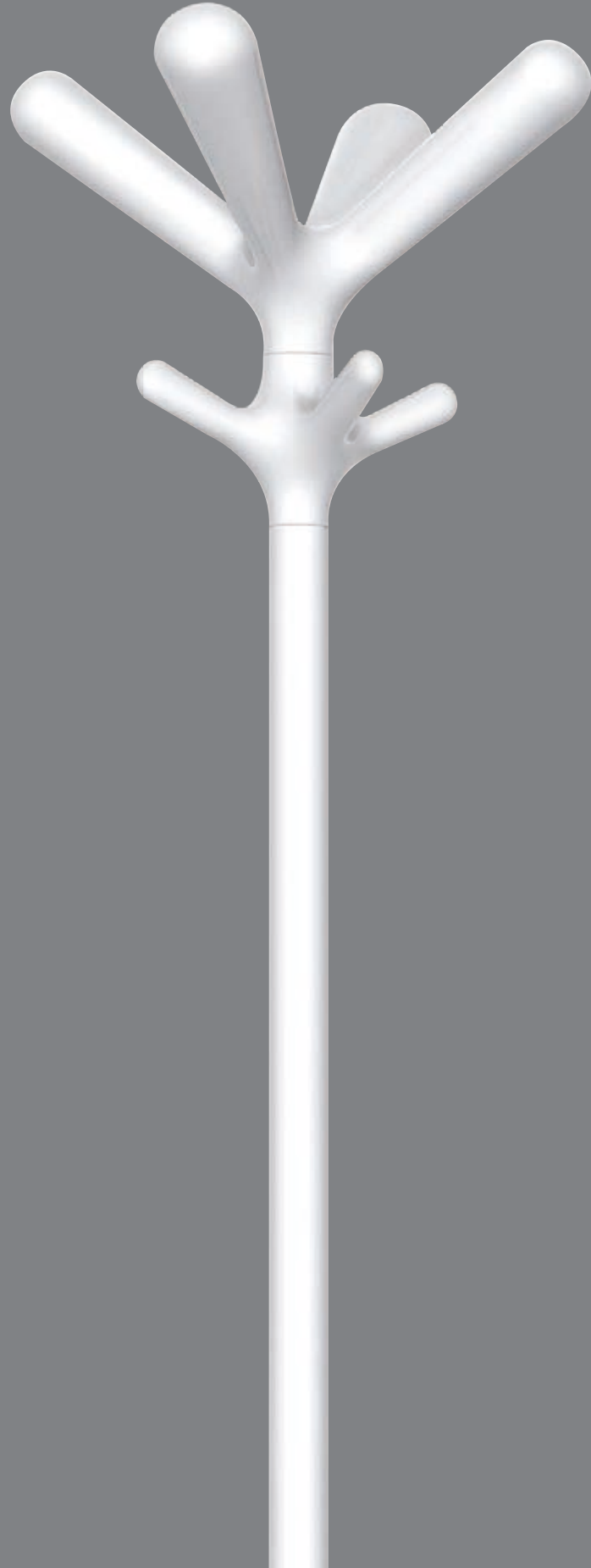

POP

design Raul Barbieri, 2008

Suggestivo appendiabiti da terra, caratterizzato dai volumi pieni e morbidi della testa, realizzata con una sofisticata tecnica di stampaggio a iniezione assistito con gas.

Testa in polimero tecnico, asta in acciaio verniciato. Base in acciaio ricoperta in polimero tecnico. Guarnizione salvapavimento in poliestere.

Kit portaombrelli opzionale in polimero tecnico.

Charming coat stand, featuring the full and soft volumes of the head, realized thanks to a sophisticated gas assisted injection-moulding process.

Engineering polymer head, painted steel rod. Steel base with engineering polymer cover. Polyester floor-protection seal.

Optional umbrella-stand kit in engineering polymer.

Ravissant porte-manteau sur pied, caractérisé par les volumes pleins et doux de la tête, réalisé par une sophistiquée technique de moulage à injection assistée au gaz.

Tête en polymère technique, tige en acier verni. Base en acier avec couverture en polymère technique. Garniture protège-sol en polyester.

Kit porte-parapluie optionnel en polymère technique.

Charmanter Kleiderständer, gekennzeichnet durch die weiche abgerundete Linienführung des Kopfes, hergestellt mit einem ausgeklügelten gasunterstützten Spritzgussverfahren.

Kopf aus technischem Polymer, Stange aus lackiertem Stahl. Stahlsockel mit Technischem-Polymer Abdeckung. Polyester Fußbodenschutz.

Optional Kit-Schirmständer aus Technischem-Polymer.

Perchero de pie con encanto, caracterizado por una cabeza de volúmenes plenos y blandos, obtenida gracias a una sofisticada técnica de moldeo de inyección asistida por gas.

Cabeza en polímero técnico, barra en acero pintado. Base en acero con cubierta en polímero técnico. Protector de suelo en poliéster.

Kit paraguero opcional en polímero técnico.



1080. POP
APPENDIABITI
COAT STAND
Ø 38 x h 167 cm
dia. 15" x h 65.75"

39.
KIT PORTAOMBRELLI
UMBRELLA STAND KIT
Ø 26,5 cm
dia. 10.5"

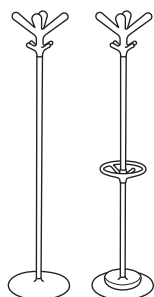



152

CACTUS

design Raul Barbieri

1995

AWARDS

THE CHICAGO ATHENAEUM
1997 – Chicago, U.S.A.



CACTUS

design Raul Barbieri, 1995

Appendiabiti da terra dalla suggestiva e inconfondibile silhouette arborea che incorpora con eleganza una vaschetta per raccogliere l'acqua e un anello portaombrelli.
Testa e anello portaombrelli in polimero tecnico, asta in acciaio verniciato. Base in acciaio ricoperta in polimero tecnico.

Coat-hanger with striking and unmistakable tree silhouette that elegantly incorporates a tray to catch the water and a umbrella ring.

Engineering polymer head and umbrella ring, painted steel rod. Steel base with engineering polymer cover.

Porte-manteau sur pied avec une silhouette suggestive et unique qui intègre avec élégance une coupe pour récupérer l'eau et un anneau porte-parapluie.

Tête et anneau porte-parapluie en polymère technique, tige en acier verni. Base en acier avec couverture en polymère technique.

Kleiderständer mit unverwechselbarem Baumprofil, der auf elegante Weise einen Wasserauffangbehälter und einen Ring-Schirmständer integriert.

Kopf und Ring-Schirmständer aus technischem Polymer, Stange aus lackiertem Stahl. Stahlsockel mit Technischem-Polymer Abdeckung.

Perchero de pie con una sugestiva e inconfundible silueta arbórea que incorpora elegantemente un recipiente para recoger el agua y un anillo paraguero.

Cabeza y anillo paraguero en polímero técnico, barra en acero pintado. Base en acero con cubierta en polímero técnico.



1070. CACTUS
APPENDIABITI
CON PORTAOMBRELLI
COAT STAND
WITH UMBRELLA STAND

Ø 40 x h 167 cm
dia. 15.75" x h 65.75"





156

DOPPIOPETTO

design Raul Barbieri

1992

AWARDS

ADI TECHNOTEL
1992 – Genova, ITALY

NESTE FORMA FINLANDIA 3
1993 – Esbo, FINLAND

FORM '93
1993 – Frankfurt, GERMANY



DOPPIOPETTO

design Raul Barbieri, 1992

Importante appendiabiti da terra, caratterizzato dall'elegante disegno dei sei confortevoli bracci di sostegno per gli abiti. Un segno distintivo autorevole, sia per ambienti domestici che aziendali.

Testa in polimero tecnico rinforzato con fibra di vetro, verniciata nero opaco o alluminio, come l'asta in acciaio. Base in acciaio ricoperta in polimero tecnico. Guarnizione salva-pavimento in poliestere.

Kit portaombrelli opzionale in polimero tecnico.

Formal coat stand featuring the elegant design of six comfortable supporting arms for clothes. A distinctive and imposing symbol for both domestic and corporate environments.

Head in fiberglass reinforced engineering polymer, matt black or aluminium painted, like the steel rod. Steel base covered in engineering polymer. Polyester floor-protection seal.

Optional umbrella-stand kit in engineering polymer.

Important porte-manteau sur pied, caractérisé par le design élégant des six confortables bras de support pour les vêtements. Un signe distinctif faisant autorité, à la fois pour la maison et les entreprises.

Tête en polymère technique renforcé à la fibre de verre, verni noir ou aluminium, comme la tige en acier. Base en acier avec couverture en polymère technique. Garniture protège-sol en polyester.

Kit porte-parapluie optionnel en polymère technique.

Markanter Kleiderständer, der sich durch die elegante Linienführung der sechs bequemen Tragarme auszeichnet. Eine Zeichen markanter Autorität in Unternehmen und zu Hause.

Kopf aus fiberglasverstärktem technischem Polymer, mattschwarz oder alufarbig lackiert wie die Stahlstange. Stahlsockel mit Technischem-Polymer Abdeckung. Polyester Fußbodenschutz.

Optional Kit-Schirmständer aus Technischem-Polymer.

Importante perchero de pie, caracterizado por el elegante diseño de sus seis cómodos brazos de soporte para la ropa. Un marcado signo distintivo, tanto para ambientes domésticos como empresariales.

Cabeza en polímero técnico reforzado con fibra de vidrio, pintada negro mate o aluminio, al igual que la barra en acero. Base en acero con cubierta en polímero técnico. Protector de suelo en poliéster.

Kit paraguero opcional en polímero técnico.



1090. DOPPIOPETTO APPENDIABITI

COAT STAND

Ø 52 x h 167 cm
dia. 20.5" x h 65.75"

29.

KIT PORTAOMBRELLI
UMBRELLA STAND KIT

Ø 28 cm
dia. 11"

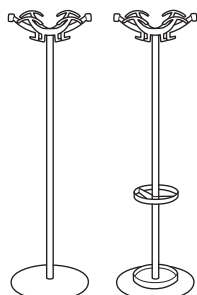

160

UNPOSTO DUEPOSTI TREPOSTI

design Raul Barbieri – Giorgio Marianelli
1986



UNPOSTO DUEPOSTI TREPOSTI

design Raul Barbieri – Giorgio Marianelli, 1986

Appendiabiti da parete in 3 modelli: singolo, oppure modulare a 2 e 3 posti, adatti per composizioni con modulo di 15 cm accostabili all'infinito. Robusti e di facile installazione, ideali per ambienti sia pubblici che domestici.
Polimero tecnico.

Wall coat hook in 3 models: single, or modular with 2 and 3 hooks, suitable for unlimited compositions with 15 cm module. Sturdy and easy to install, ideal for both public and domestic environments.
Engineering polymer.

Patères en 3 modèles: simple, ou modulaire de 2 et 3 places, adapté aux compositions avec module de 15 cm intégrable à l'infini. Robustes et facile à installer, idéales pour environnements publics et domestiques.
Polymère technique.

Wandkleiderhaken in drei Modellen: einzeln, oder modular mit 2 und 3 Plätzen, für Modulkombinationen mit 15 cm Länge geeignet, die sich unendlich erweitern lassen. Robust und einfach zu installieren, ideal für den Einsatz in öffentlichen Räumen und zu Hause.
Technisches-Polymer.

Perchas de pared disponibles en 3 modelos: individual, o modular de 2 o 3 plazas, ideales para composiciones con módulos de 15 cm colocables de infinitas maneras. Robustos y de fácil instalación, ideales tanto para ambientes públicos como domésticos.
Polímero técnico.



991.



992. / 993.

991. UNPOSTO APPENDIABITI DA PARETE SINGOLO SINGLE WALL COAT HANGER

9,5 x 7,5 x h 10 cm
3.75" x 3" x h 4"



992. DUEPOSTI APPENDIABITI DA PARETE DOPPIO TRIPLE WALL COAT HANGER

30 x 7,5 x h 10 cm
11.75" x 3" x h 4"



993. TREPOSTI APPENDIABITI DA PARETE TRIPLO TRIPLE WALL COAT HANGER

45 x 7,5 x h 10 cm
17.75" x 3" x h 4"





164

GRU

design Raul Barbieri
2008



GRU

design Raul Barbieri, 2008

Una forma morbida e piena, ideale per appendere gli abiti senza deformarli, ottenuta grazie ad una sofisticata tecnica di stampaggio a iniezione assistito con gas.
Polimero tecnico.

A soft and full form, ideal for hanging clothes without them misshapen, achieved thanks to a sophisticated gas assisted injection-moulding process.
Engineering polymer.

Une forme pleine et douce, idéale pour suspendre les vêtements sans les déformer, réalisé par une sophistiquée technique de moulage à injection assistée au gaz.
Polymère technique.

Kleiderbügel mit weicher abgerundeter Linienführung, mit dem sich Kleidungsstücke knitterfrei aufhängen lassen, hergestellt mit einem ausgeklügelten gasunterstütztem Spritzgussverfahren.
Technisches-Polymer.

Una forma suave y plena, ideal para colgar la ropa sin estropearla, obtenida gracias a una sofisticada técnica de moldeo de inyección asistida por gas.
Polímero técnico.



998. GRU
GRUCCIA
HANGER
43 x 3,5 x h 18,5 cm
17" x 1,5" x h 7,25"





168

CRIBBIO

design Raul Barbieri – Giorgio Marianelli
1981

AWARDS

17° SMAU INDUSTRIAL DESIGN
1984 – Milano, ITALY

XVII PREMIO NAZIONALE ARTI VISIVE
1993 – Gallarate, ITALY



CRIBBIO

design Raul Barbieri – Giorgio Marianelli, 1981

Storica famiglia di cestini gettacarte, portaombrelli, appendiabiti e posacenere da terra. Si distingue per i contenitori, realizzati senza saldature da un'unica lastra di acciaio, imbutita e poi traforata radialmente, consentendo così un'impareggiabile leggerezza e robustezza.

Contenitori e aste in acciaio. Appendiabiti con testa e ganci in polimero tecnico. Guarnizione salva-pavimento in poliestere.

Historical collection of waste baskets, umbrella stands, coat stand and floor ashtrays, standing out thanks to their containers, made without weldings from a single steel sheet, drawn and then radially perforated, allowing for incomparable lightness and solidity.

Steel containers and rods. Coat stand with engineering polymer head and hooks. Polyester floor-protection seal.

Famille historique de corbeilles à papier, porte-parapluies, portemanteaux et cendriers sur pied caractérisée par les conteneurs, fabriqués sans soudures à partir d'une unique plaque d'acier emboutie et puis perforée radialement, apportant ainsi une résistance et une légèreté incomparables.

Conteneurs et tiges en acier. Porte-manteaux avec tête et patères en polymère technique. Garniture protège-sol en polyester.

Historische Produktfamilie von Papierkörben, Schirmständern, Kleiderständern und Standaschenbechern, die sich durch ihre Behälter aus einem einzigen Stück tiefgezogenem Stahlblech ohne Schweißnähte, der im Anschluss radial perforiert wird, auszeichnen, und für eine unvergleichliche Leichtigkeit und Strapazierfähigkeit sorgen.

Behälter und Stange aus Stahl. Kleiderständer mit Kopf und Haken aus Technischem-Polymer. Polyester Fußbodenschutz.

Histórica familia de papeleras, paragüeros, percheros y ceniceros de pie que se distingue por sus contenedores realizados sin soldaduras a partir de una sola placa de acero, embutida y perforada radialmente, lo que les confiere una inigualable ligereza y robustez.

Contenedores y barras en acero. Perchero con cabeza y ganchos en polímero técnico. Protector de suelo en poliéster.

1000. CRIBBIO

CESTINO GETTACARTE

WASTE BASKET

Ø 26,5 x h 30,5 cm (15 litri/litres)
dia. 10.5" x h 12" (4 gallons)



1010. CRIBBIO

CESTINO ALTO / PORTAOMBRELLI

TALL WASTE BASKET / UMBRELLA STAND

Ø 26,5 x h 45 cm (22 litri/litres)
dia. 10.5" x h 17.75" (5.75 gallons)



15.

VASCHETTA ECOLOGICA

ECO-FRIENDLY CUP

19 x h 12,5 x h 15 cm (1,5 litri/litres)
7.5" x 5" x h 6" (0.5 gallons)



1020. CRIBBIO

POSACENERE CON CESTINO GETTACARTE

FLOOR ASHTRAY WITH WASTE BASKET

Ø 26,5 x h 65 cm
dia. 10.5" x h 25.5"



1030. CRIBBIO

APPENDIABITI CON PORTAOMBRELLI

COAT STAND WITH UMBRELLA STAND

Ø 26,5 x h 168 cm
dia. 10.5" x h 66.25"

1020.

1030.









174

COLMO

design Raul Barbieri – Giorgio Marianelli
2003



COLMO

design Raul Barbieri – Giorgio Marianelli, 2003

Variante priva di forature della storica famiglia Cribbio. Tutti i contenitori sono realizzati senza saldature, da un'unica lastra di acciaio imbutita.

Contenitori e aste in acciaio. Appendiabiti con testa e ganci in polimero tecnico. Guarnizione salva-pavimento in poliester.

Variation without perforations of the historical Cribbio collection. All the containers are made without weldings, from a single drawn steel sheet.

Steel containers and rods. Coat stand with engineering polymer head and hooks. Polyester floor-protection seal.

Variante sans perforations de la famille historique Cribbio. Tous les conteneurs sont fabriqués sans soudures, à partir d'une unique plaque d'acier emboutie.

Conteneurs et tiges en acier. Porte-manteaux avec tête et patères en polymère technique. Garniture protège-sol en polyester.

Nicht perforierte Variante der klassischen Cribbio-Familie. Alle Behälter sind aus einem einzigen Stück tiefgezogenem Stahlblech, ohne Schweißnähte gefertigt.

Behälter und Ständer aus Stahl. Kleiderständer mit Kopf und Haken aus Technischem-Polymer. Polyester Fußbodenschutz.

Variante sin perforaciones de la histórica familia Cribbio. Todos los contenedores están realizados sin soldaduras, a partir de una sola placa de acero embutida.

Contenedores y barras en acero. Perchero con cabeza y ganchos en polímero técnico. Protector de suelo en poliéster.

1050. COLMO
CESTINO GETTACARTE

WASTE BASKET

Ø 26,5 x h 30,5 cm (15 litri/litres)
dia. 10.5" x h 12" (4 gallons)

**1051. COLMO**
CESTINO ALTO / PORTAOMBRELLI

TALL WASTE BASKET / UMBRELLA STAND

Ø 26,5 x h 45 cm (22 litri/litres)
dia. 10.5" x h 17.75" (5.75 gallons)

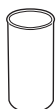
**15.**
VASCHETTA ECOLOGICA

ECO-FRIENDLY CUP

19 x h 12,5 x h 15 cm (1,5 litri/litres)
7.5" x 5" x h 6" (0.5 gallons)

**1052. COLMO**
POSACENERE CON CESTINO GETTACARTE

FLOOR ASHTRAY WITH WASTE BASKET

Ø 26,5 x h 65 cm
dia. 10.5" x h 25.25"

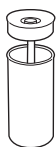

1052.

1053.

1053. COLMO
APPENDIABITI CON PORTAOMBRELLI

COAT STAND WITH UMBRELLA STAND

Ø 26,5 x h 168 cm
dia. 10.5" x h 66.25"





178

ECO

design Raul Barbieri
1993

AWARDS

ECO

FORM '94
1994 – Frankfurt, GERMANY

ECO PRO

ADI DESIGN INDEX 99
2000 – Milano, ITALY



ECO

design Raul Barbieri, 1993

Perfetta sintesi di eleganza e di efficienza, il cestino Eco può essere dotato sia di una vaschetta dedicata alla raccolta differenziata, per facilitare la separazione della carta, che di un anello per fermare e nascondere il bordo del sacchetto. Cestino, vaschetta e anello in polimero tecnico.

Perfect combination of elegance and efficiency, the Eco basket can be fitted with both an eco-friendly cup to make it easy to separate paper, and a ring to hold and hide the edge of the bag.

Engineering polymer basket, cup and ring.

Synthèse parfaite d'élégance et efficacité, la corbeille à papier Eco peut être aussi équipée d'une coupe dédié à la collecte séparée pour permettre une séparation facile du papier, et d'un anneau pour fermer et cacher le bord du sac.

Corbeille, coupe et anneau en polymère technique.

Als perfekte Synthese aus Eleganz und Effizienz ist der Papierkorb Eco sowohl mit einer Schale für eine leichtere Abfalltrennung, als auch mit einem Abfallsack-Abdeckring erhältlich, der den Müllbeutel festhält und versteckt.

Papierkorb, Schale und Abdeckring aus Technischem-Polymer.

Síntesis perfecta de elegancia y eficiencia, la papelera Eco puede equiparse tanto de una cubeta para la recogida de residuos que facilita la separación del papel, como de un anillo para fijar y ocultar el borde de la bolsa.

Papelera, cubeta y anillo en polímero técnico.

**1500. ECO**

CESTINO GETTACARTE

WASTE BASKET

28 x 28 x h 32 cm (13,5 litri/litres)
11" x 11" x h 12.5" (3.5 gallons)

**16.**

VASCHETTA ECOLOGICA

ECO-FRIENDLY CUP

25 x 16 x h 15 cm (2 litri/litres)
9.75" x 6.5" x h 6" (0.5 gallons)

**17.**

ANELLO COPRISACCHETTO

BAG COVER RING

29,5 x 29,5 x h 7 cm
11.5" x 11.5" x h 2.75"





ECO PRO

design Raul Barbieri, 1993

Nella versione Eco Pro, il cestino, la vaschetta e l'anello sono realizzati in polipropilene.

Cestino, vaschetta e anello in polipropilene, in colori traslucidi oppure nero.

In the Eco Pro version, basket, cup and ring are produced in polypropylene.

Basket, cup and ring in polypropylene, in translucent colours or black.

Dans la version Eco Pro, la corbeille, la coupe et l'anneau sont réalisés en polypropylène.

Corbeille, coupe et anneau en polypropylène, en couleurs translucides ou noir.

In der Eco Pro Version sind Papierkorb, Schale und Abdeckung aus Polypropylen.

Papierkorb, Schale und Abdeckung aus Polypropylen, in durchscheinenden Farben oder schwarz.

En la versión Eco Pro, la papelera, la cubeta y el anillo están fabricados en polipropileno.

Papelera, cubeta y anillo en polipropileno, en colores translúcidos o negro.



1500.PP. ECO PRO
CESTINO GETTACARTE
WASTE BASKET

28 x 28 x h 32 cm (13,5 litri/litres)
11" x 11" x h 12.5" (3,5 gallons)



16.PP.
VASCHETTA ECOLOGICA
ECO-FRIENDLY CUP

25 x 16 x h 15 cm (2 litri/litres)
9.75" x 6.5" x h 6" (0,5 gallons)



17.PP.
ANELLO COPRISACCHETTO
BAG COVER RING

29,5 x 29,5 x h 7 cm
11.5" x 11.5" x h 2.75"





184

TABOO

design Raul Barbieri

2008

AWARDS

ADI DESIGN INDEX
2009 – Milano, ITALY

XXII COMPASSO D'ORO – Menzione d'Onore
2011 – Milano, ITALY



TABOO

design Raul Barbieri, 2008

L'originale maniglia dona personalità e praticità di utilizzo a questo cestino dall'invitante apertura inclinata, che può essere dotato di un'analogo vaschetta con maniglia dedicata alla raccolta differenziata, per facilitare la separazione della carta. Cestino e vaschetta in polimero tecnico.

The unusual handle lends personality and practicality of use to this basket with inviting inclined opening, which can be fitted with an eco-friendly cup with a similar handle to allow the paper to be easily separated for recycling.

Engineering polymer basket and cup.

La poignée originale apporte personnalité et facilité d'utilisation à cette corbeille avec une accueillante ouverture inclinée, qui peut être équipée d'une coupe avec poignée similaire, dédiée à la collecte séparée, pour permettre une séparation facile du papier lors du tri sélectif.

Corbeille et coupe en polymère technique.

Sein origineller Griff verleiht diesem Papierkorb Persönlichkeit und Praktikabilität, die durch die geneigte Öffnung noch verstärkt wird. Für die Abfalltrennung ist eine ähnliche Schale mit Griff erhältlich.

Papierkorb und Schale aus Technischem-Polymer.

La original asa confiere personalidad y comodidad de uso a esta papelera con acogedora abertura inclinada, que puede equiparse con una similar cubeta con asa para la recogida de residuos, por facilitar la separación del papel durante la clasificación de basuras.

Papelera y cubeta en polímero técnico.



1460. TABOO
CESTINO GETTACARTE
WASTE BASKET

26 x 28 x h 35 cm (13,5 litri/litres)
10.25" x 11" x h 13.75" (3.5 gallons)



18.
VASCHETTA ECOLOGICA
ECO-FRIENDLY CUP

24 x 14,5 x h 17 cm (3 litri/litres)
9.5" x 5.75" x h 6.75" (0.75 gallons)





188

BIRILLO

design Giotto Stoppino

1982

AWARDS

17° SMAU INDUSTRIAL DESIGN
1984 – Milano, ITALY



BIRILLO

design Giotto Stoppino, 1982

Cestini gettacarte, portaombrelli e posacenere da terra dalla garbata linea classica caratterizzata dal bordo superiore arrotondato, si inseriscono facilmente sia nella casa come in ambienti di lavoro.

Contenitori in polimero tecnico, vaschetta posacenere in acciaio verniciato o cromato.

Graceful, classic style waste baskets, umbrella stand and floor ashtray with rounded top edge, allowing it to be easily placed in either a domestic or working environment.

Engineering polymer containers, ashtray cup in painted or chromed steel.

Corbeilles à papier, portes-parapluies et cendriers de sol aux douces lignes classiques, caractérisé par un bord supérieur arrondi, ils s'intègrent facilement à la maison comme au travail.

Conteneurs en polymère technique, coupe cendrier en acier verni ou chromé.

Papierkörbe, Schirmständer und Standaschenbecher mit einer klassischen Linienführung mit abgerundeter Oberkante, die sich perfekt für zu Hause und Arbeitsumgebungen eignen.

Behälter aus Technischem-Polymer, Aschenschale aus lackiertem oder verchromtem Stahl.

Papeleras, paragüeros y ceniceros de pie de agradable línea clásica, caracterizada por el borde superior redondeado, se introducen fácilmente tanto en el hogar como en entornos empresariales.

Contenedores en polímero técnico, cubeta cenicero en acero pintado o cromado.

1100. BIRILLO CESTINO GETTACARTE WASTE BASKET

Ø 25,5 x h 38 cm (18 litri/litres)
dia. 10" x h 15" (4.75 gallons)



1200. BIRILLO PORTAOMBRELLI / POSACENERE DA TERRA UMBRELLA STAND / FLOOR ASHTRAY

Ø 25,5 x h 60 cm (18 litri/litres)
dia. 10" x h 23.5" (4.75 gallons)



30. VASCHETTA POSACENERE ASHTRAY CUP

Ø 22 x h 6 cm
dia. 8.5" x h 2.5"



15. VASCHETTA ECOLOGICA ECO-FRIENDLY CUP

19 x 12,5 x h 15 cm (1.5 litri/litres)
7.5" x 5" x h 6" (0.5 gallons)





BIRILLO PLUS

design Giotto Stoppino, 2004

Nella versione Birillo Plus, il corpo del cestino è senza fondo per accogliere al suo interno un contenitore in metallo dal quale sarà facile estrarre e svuotare il sacchetto porta-rifiuti, che resterà sempre invisibile.

Corpo del cestino in polimero tecnico, contenitore interno in banda stagnata.

In the Birillo Plus version, the body of the basket is baseless in order to hold inside a metal can from where it will be easy to remove and empty the rubbish bag holder, which will always be out of view.

Basket body in engineering polymer, internal can in white latten.

Dans la version Birillo Plus, le corbeille est sans fond pour accueillir à l'intérieur un conteneur métallique grâce auquel il sera facile d'enlever et de vider le sac poubelle, qui restera toujours invisible.

Corps de la corbeille en polymère technique, conteneur intérieur en tôle étamée.

In der Version Birillo Plus, hat der Korpus des Papierkorbes keinen Boden um einen Metallbehälter zu enthalten, der mit dem Müllbeutel leicht herausgenommen und entleert werden kann.

Papierkorb Korpus aus Technischem-Polymer, Innenbehälter aus Weißblech.

En la versión Birillo Plus, el cuerpo de la papelera no tiene fondo para dar cabida en su interior a un contenedor metálico para la bolsa de basura, que siempre permanecerá invisible.

Cuerpo de la papelera en polímero técnico, contenedor interior en hojalata.



1102. BIRILLO PLUS

CESTINO GETTACARTE

WASTE BASKET

Ø 25,5 x h 38 cm (18 litri/litres)
dia. 10" x h 15" (4.75 gallons)



15.

VASCHETTA ECOLOGICA

ECO-FRIENDLY CUP

19 x 12,5 x h 15 cm (1,5 litri/litres)
7.5" x 5" x h 6" (0.5 gallons)





STATUS

design Raul Barbieri

1991

AWARDS

FORUM OFFICE DESIGN
1991 – Milano, ITALY

DESIGN PLUS
1992 – Frankfurt, GERMANY

INDUSTRIE FORUM DESIGN
1992 – Hannover, GERMANY

ADI TECHNOTEL
1992 – Genova, ITALY

XVII PREMIO NAZIONALE ARTI VISIVE
1993 – Gallarate, ITALY

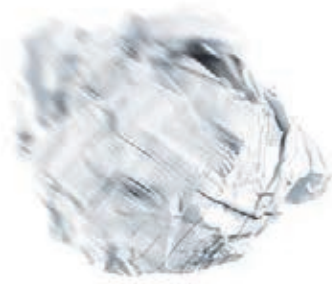

STATUS

design Raul Barbieri, 1991

Cestini gettacarte e portaombrelli per uffici direzionali. Il disegno minimalista e ricercato ne consente l'elegante integrazione con un anello copri-sacchetto o un anello con coperchio basculante. Polimero tecnico verniciato nero opaco o alluminio. Guarnizione salva-pavimento in poliester.

Waste baskets and umbrella stands for executive offices. The minimalist, sophisticated design ensures an elegant integration with a cover-bag ring or a ring with flip top lid. Engineering polymer, matt black or aluminium painted. Polyester floor-protection seal.

Corbeilles à papier et porte-parapluies pour les bureaux de direction. Le design minimaliste et raffiné permet l'intégration élégante d'un anneau couvre-sac ou d'un anneau avec couvercle basculant.

Polymère technique verni noir mat ou aluminium. Garniture protège-sol en polyester.

Papierkörbe und Schirmständer für Chefbüros. Das minimalistische und edle Design ermöglicht das Aufsetzen eines eleganten Abfallsack-Abdeckrings oder eines Rings mit Schwingdeckel.

Technisches-Polymer, matt-schwarz oder alufarbig lackiert. Polyester Fußbodenschutz.

Papeleras y paragueros para oficinas de dirección. Su diseño minimalista permite equiparlos con elegantes anillos cubrebolsas o anillos con tapa basculante.

Polímero técnico pintado negro mate o aluminio. Protector de suelo en poliéster.

1400. STATUS

CESTINO GETTACARTE

WASTE BASKET

Ø 30 x h 32 cm (18 litri/litres)
dia. 11.75" x h 12.5" (4.75 gallons)



1440. STATUS

CESTINO ALTO / PORTAOMBRELLI

TALL WASTE BASKET / UMBRELLA STAND

Ø 30 x h 52 cm (30 litri/litres)
dia. 11.75" x h 20.5" (8 gallons)



20.

ANELLO COPRISACCHETTO

BAG COVER RING

Ø 30 x h 10 cm
dia. 11.75" x h 4"



21.

ANELLO CON COPERCHIO BASCULANTE

RING WITH FLIP TOP LID

Ø 30 x h 10 cm
dia. 11.75" x h 4"



15.

VASCHETTA ECOLOGICA

ECO-FRIENDLY CUP

19 x 12,5 x h 15 cm (1,5 litri/litres)
7,5" x 5" x h 6" (0,5 gallons)





198

BABELE

design Raul Barbieri – Giorgio Marianelli
1978

AWARDS

WORKSPHERES (MOMA)
2001 – New York, U.S.A.



BABELE

design Raul Barbieri – Giorgio Marianelli, 1978

Set da scrivania dall'inconfondibile disegno leggero ed elegante che prende il nome da Babele, la storica vaschetta portacorrispondenza nata nel 1980, ancora oggi uno straordinario best seller.

Babele, Memo e Podio in polimero tecnico. Centobuchi e Slim in polimero tecnico e alluminio. Modus in gomma naturale con vaschetta portamatite in polimero tecnico.

Desk set with unmistakable light and elegant design that takes its name from Babele, the historical letter tray born in 1980, still an extraordinary best seller today.

Babele, Memo and Podio in engineering polymer. Centobuchi and Slim in engineering polymer and aluminium. Modus in natural rubber with an engineering polymer pencil tray.

Set de bureau a l'incomparable design aérien et élégant qui tire son nom de Babele, l'historique corbeille à courrier né en 1980, un best-seller extraordinaire aujourd'hui encore.

Babele, Memo et Podio en polymère technique. Centobuchi et Slim en polymère technique et aluminium. Modus en caoutchouc naturel avec plumier en polymère technique.

Schreibtisch-Set im unverwechselbar leicht-eleganten Design, das den Namen der historischen Briefablage Babele, 1980 geboren, wieder aufnimmt und immer noch ein außergewöhnlicher Bestseller ist.

Babele, Memo und Podio aus Technischem-Polymer. Centobuchi und Slim aus Technischem-Polymer und Aluminium. Modus aus Kautschuk mit Stiftablage aus Technischem-Polymer.

Set de escritorio de inconfundible diseño elegante y ligero que toma su nombre de la histórica bandeja porta-correspondencia Babele, nacida en 1980, que sigue siendo un éxito de ventas extraordinario.

Babele, Memo y Podio en polímero técnico. Centobuchi y Slim en polímero técnico y aluminio. Modus en caucho natural con bandeja portalápices en polímero técnico.

940. BABELE
PORTACORRISPONDENZA
LETTER TRAY
25,5 x 35 x h 7 cm
10" x 13.75" x h 2.75"

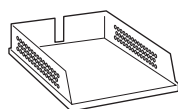

921. PODIO
PORTACARTE
LETTER RACK
24 x 4,5 x h 9,5 cm
9.5" x 1.75" x h 3.75"



924. SLIM
VASCHETTA PORTAMATITE
PENCIL TRAY
27,5 x 9 x h 3,5 cm
11" x 3.5" x h 1.5"

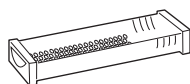

930. CENTOBUCHI
BICCHIERE PORTAMATITE
PENCIL CUP
Ø 8 x h 10 cm
dia. 3.25" x h 4"



944. MEMO
PORTAMEMO
MEMO PAD HOLDER
11 x 11 x h 7 cm
4.5" x 4.5" x h 2.75"



400. MODUS
design Kuno Prey, 1991
SOTTOMANO CON PORTAMATITE
DESK PAD WITH PENCIL TRAY
60 x 45 x h 0,6 cm
23.5" x 17.75" x h 0.25"









204

STANDARD

design Julian Brown

2004

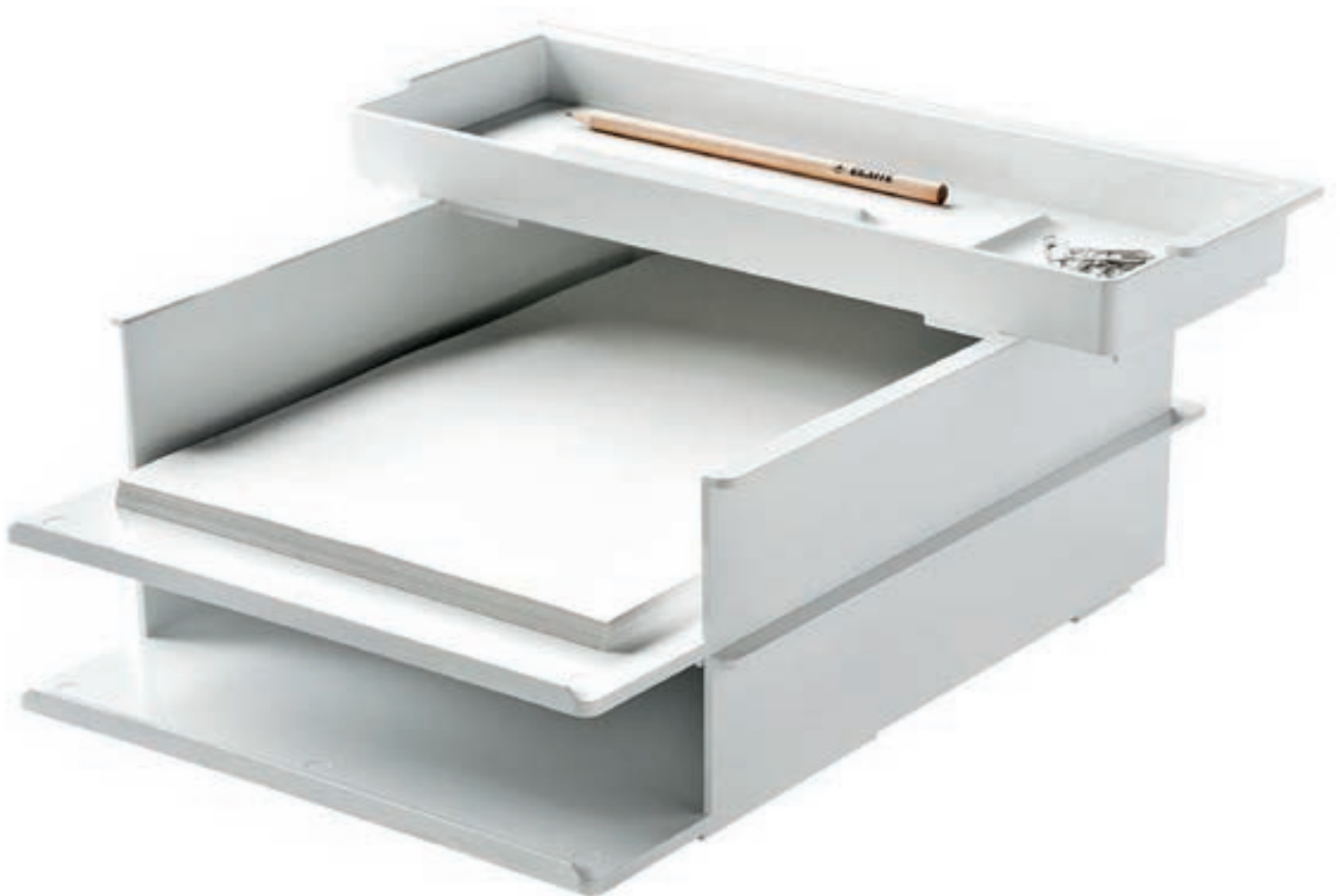

STANDARD

design Julian Brown, 2004

Un versatile set da scrivania dal disegno essenziale ed elegante, dotato di agganci per consentirne l'utilizzo anche a parete. Le vaschette portacorrispondenza, disponibili con apertura frontale o laterale, si affiancano al bicchiere portamatite, alla vaschetta portamatite, al porta-memo e al sottomano.

Set in polimero tecnico, sottomano in linoleum.

A versatile desk set with an essential and elegant line, provided with hooks to allow them to be hung on the wall. The letter trays, available with front or side opening are accompanied by the pencil cup, the pencil tray, the memo-pad holder and the desk pad.

Engineering polymer desk set, linoleum desk pad.

Un set de bureau polyvalent d'un design essentiel et élégant, équipé de crochets pour permettre aussi leur utilisation sur paroi. Les corbeilles à courrier, disponibles avec ouverture frontale ou latérale, sont accompagnées du pot à crayons, du plumier, du porte-mémo et du sous-main.

Set en polymère technique, sous-main en linoléum.

Ein vielseitiges Schreibtisch-Set mit wesentlichem und elegantem Design, mit Aufhängung für eine Verwendung auch an der Wand. Die Frontal- oder Seitliche-Briefablagen passen neben Stiftköcher, Stiftablage, Zettelbox und Schreibunterlage.

Zubehör aus Technischem-Polymer, Schreibunterlage aus Linoleum.

Versátil set de escritorio de línea esencial y elegante, dotado de ganchos para poder fijarlo a la pared. Las bandejas portacorrespondencia, disponibles con apertura frontal o lateral, acompañan cubilete portalápices, bandeja portalápices, porta notas y vade sobremesa.

Set en polímero técnico, vade sobremesa en linóleo.

650. STANDARD
PORTACORRISPONDENZA FRONTALE
FRONT LETTER TRAY
27 x 34,5 x h 6,5 cm
10,5" x 13,5" x h 2,5"

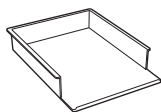

655. STANDARD
PORTACORRISPONDENZA LATERALE
SIDE LETTER TRAY
35,5 x 26 x h 6,5 cm
14" x 10,25" x h 2,5"

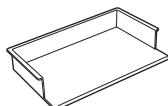

610. STANDARD
VASCHETTA PORTAMATITE
PENCIL TRAY
35,5 x 12,5 x h 3,5 cm
14" x 5" x h 1,5"



632. STANDARD
BICCHIERE PORTAMATITE
PENCIL CUP
9 x 9 x h 9,5 cm
3,5" x 3,5" x h 3,75"



640. STANDARD
PORTAMEMO / PORTACD
MEMO PAD / CD HOLDER
12,5 x 12,5 x h 6,5 cm
5" x 5" x 2,5"



904. PLANO
SOTTOMANO
DESK PAD
60 x 45 x h 0,3 cm
23,5" x 17,75" x h 0,25"

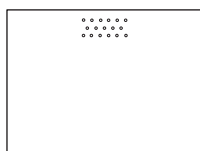







STANDARD WALL

design Julian Brown, 2004

Tutti i componenti del set da scrivania Standard possono essere posizionati anche a parete, su appositi binari a uno o tre livelli disponibili in tre lunghezze (80, 100 e 120 cm), affiancabili liberamente sia in larghezza come in altezza. Binari in alluminio anodizzato naturale.

All the pieces in the standard desk set can also be placed on wall, on special beams at one or three levels available in three lengths (80, 100 and 120 cm), freely nestable either in width or in height.

Wall beams in anodised aluminium.

Tous les composants du set de bureau Standard peuvent également être placés sur paroi, sur des rails spéciaux de un ou trois niveaux, disponibles en trois longueurs (80, 100 et 120 cm), assemblables côte à côte, sans limitations tant en largeur qu'en hauteur.

Rails en aluminium anodisé.

Alle Komponenten des Schreibtisch-Set's Standard können auch an der Wand befestigt werden. Die dazugehörigen Aluprofil-Wandbefestigungen mit einer oder drei Ebenen, können in drei Längen (80, 100 und 120 cm) grenzenlos, über- oder nebeneinander angeordnet werden.

Aluprofil-Wandbefestigung aus eloxiertem Aluminium.

Todos los componentes del set de escritorio Standard también pueden fijarse a la pared, sobre barras especiales de uno o tres niveles, disponibles en tres longitudes, 80, 100 y 120 cm, colocables de forma continua indefinidamente, tanto a lo ancho como a lo alto.

Barras en aluminio anodizado natural.

STANDARD WALL BINARIO DA PARETE – 1 LIVELLO

WALL BEAM – 1 LEVEL

B080. 80 x 1 x h 6 cm
31" x 0.5" x h 2.25"

B100. 100 x 1 x h 6 cm
39.5" x 0.5" x h 2.25"

B120. 120 x 1 x h 6 cm
47.25" x 0.5" x h 2.25"

610. STANDARD WALL BINARIO DA PARETE – 3 LIVELLI

WALL BEAM – 3 LEVELS

C080. 80 x 1 x h 20,5 cm
31" x 0.5" x h 8"

C100. 100 x 1 x h 20,5 cm
39.5" x 0.5" x h 8"

C120. 120 x 1 x h 20,5 cm
47.25" x 0.5" x h 8"

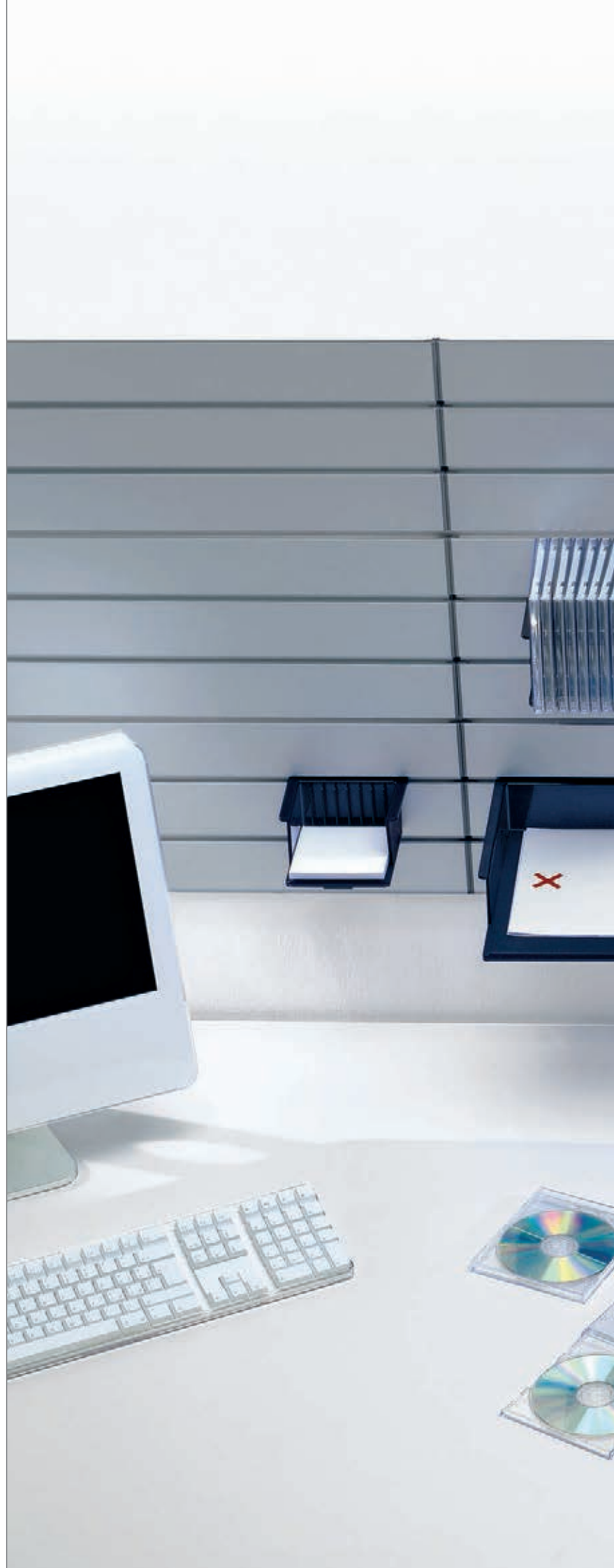
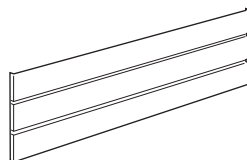
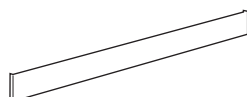



STATUS

design Raul Barbieri

1989

AWARDS

FORUM OFFICE DESIGN

1989 – Milano, ITALY

FORM '90

1990 – Frankfurt, GERMANY

XVI COMPASSO D'ORO – Menzione d'Onore

1991 – Milano, ITALY

XVII PREMIO NAZIONALE ARTI VISIVE

1993 – Gallarate, ITALY



STATUS

design Raul Barbieri, 1989

Set da scrivania per uffici direzionali, connotato dal raffinato disegno minimalista e dalla scelta di materiali pregiati.

Vassoio, bicchiere portamatite, e porta-memo in alluminio pressofuso, portacorrispondenza in polimero tecnico di forte spessore verniciato alluminio o nero opaco. Sottomano grande e piccolo in poliuretano integrale.

Desk set for executive offices featuring an elegant, minimalist design and the selection of fine materials.

Tray, pencil cup and memo pad-holder in die cast aluminium, letter tray in thick engineering polymer aluminium or matt black painted. Large and small desk pad in integral polyurethane.

Set de bureau pour bureaux de direction, caractérisé par un élégant design minimaliste et le choix de matériaux nobles.

Plateau, pot à crayons et porte-memo en aluminium moulé sous pression, corbeille à courrier en polymère technique avec forte épaisseur verni aluminium ou noir mat. Sous-main grand et petit en polyuréthane intégrale.

Schreibtisch-Set für Chefbüros mit raffiniert minimalistischem Design und kostbaren Materialien.

Tischablage, Stiftköcher, und Zettelbox aus Aluminium-Spritzguss, Briefablage aus dickem Technischem-Polymer alufarbig oder matt-schwarz lackiert. Große und kleine Schreibunterlage aus Integral-Polyurethan.

Set de escritorio para oficinas de dirección, caracterizado por un refinado diseño minimalista y una selección de materiales preciados.

Bandeja, cubilete portalápices y porta notas en aluminio moldeado a presión, bandeja porta correspondencia en polímero técnico de gran espesor pintado aluminio o negro mate. Vade sobremesa grande y pequeño en poliuretano integral.

350. STATUS
PORTACORRISPONDENZA
LETTER TRAY
26 x 35 x h 7 cm
10.25" x 13.75" x h 2.75"

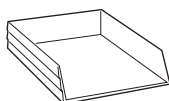

332. STATUS
BICCHIERE PORTAMATITE
PENCIL CUP
Ø 9 x h 9 cm
dia. 3.5" x h 3.5"



340. STATUS
PORTAMEMO
MEMO PAD HOLDER
15 x 15 x h 2,5 cm
6" x 6" x h 1"

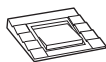

330. STATUS
VASSOIO PER TAVOLI RIUNIONE
TRAY FOR MEETING DESKS
30 x 30 x h 2,5 cm
11.75" x 11.75" x h 1"

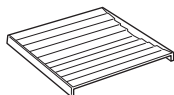

300. STATUS
SOTTOMANO
DESK PAD
70 x 50 x h 0,4 cm
27.5" x 19.75" x h 0.125"

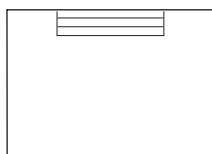

303. STATUS
SOTTOMANO CON SEGNAPOSTO
DESK PAD WITH NAME HOLDER
28 x 40 x h 1,5 cm
11" x 15.75" x h 0.5"

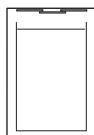







ACCESSORI DA SCRIVANIA DESK ACCESSORIES

design Raul Barbieri – Giorgio Marianelli
Julian Brown
Rino Pirovano

AWARDS

HANNIBAL

I.D. MAGAZINE – Best of Category
1998 – New York, U.S.A.

TIME MAGAZINE – Best of Design 1998
1998 – New York, U.S.A.

DESIGN CENTER STUTTGART
1998 – Stuttgart, GERMANY

THE CHICAGO ATHENAEUM
1998 – Chicago, U.S.A.

NATIONAL STATIONERY SHOW – Best Product
1998 – New York, U.S.A.

FORM '99
1998 – Frankfurt, GERMANY



ARTICOLI DA SCRIVANIA DESK ACCESSORIES

design Raul Barbieri – Giorgio Marianelli
Julian Brown
Rino Pirovano

Tutti i set da scrivania possono essere completati da questi accessori utilissimi sia in ufficio come a casa: il magico dispenser di nastro adesivo **Hannibal**, il portaoggetti con cassette rotanti **Multiplor**, le coppie di reggilibri **Duplo** e **Gemini**, i posacenere da tavolo **Safe Tray** e **Nox**.

Hannibal e Multiplor sono in polimero tecnico e acciaio, Duplo e Gemini in acciaio, Safe Tray in alluminio e polimero tecnico, Nox in acciaio inossidabile lucidato.

All the desk sets can be completed with these accessories, very useful both in the office and at home: the magic tape dispenser **Hannibal**, the rotating desk organizer **Multiplor**, the bookend pairs **Duplo** and **Gemini**, the table ashtrays **Safe Tray** and **Nox**.

Hannibal and Multiplor are in engineering polymer and steel, Duplo and Gemini in steel, Safe Tray in aluminium and engineering polymer, Nox in polished stainless steel.



500. HANNIBAL

design Julian Brown, 1998

DISPENSER DI NASTRO ADESIVO

TAPE DISPENSER

8 x 10,5 x h 9,5 cm
3" x 4" x h 3.75"

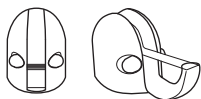

916. DUPLO

design Raul Barbieri – Giorgio Marianelli, 1980

REGGILIBRI (COPPIA)

BOOKENDS (PAIR)

14 x 14 x h 20 cm
5,5" x 5,5" x h 8"

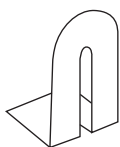

919. GEMINI

design Raul Barbieri – Giorgio Marianelli, 1977

REGGILIBRI (COPPIA)

BOOKENDS (PAIR)

15 x 15 x h 20 cm
6" x 6" x h 8"

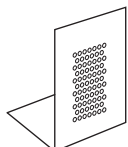

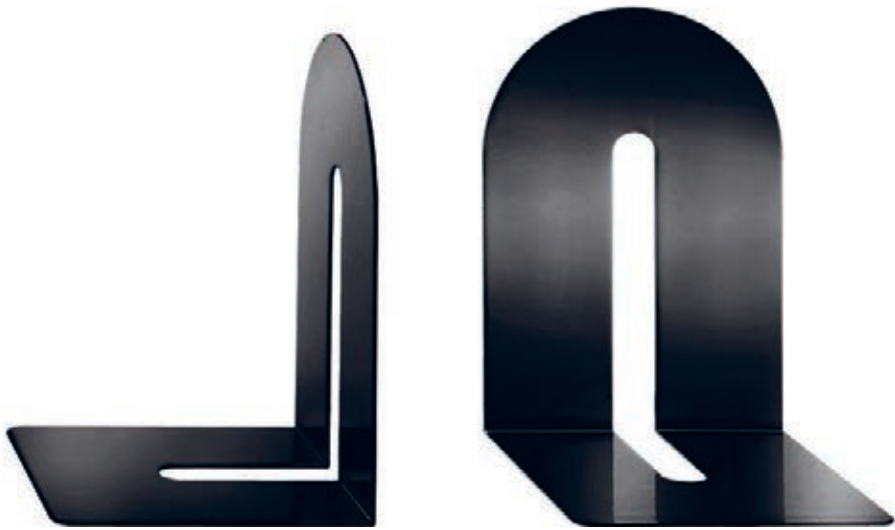

Tout les sets de bureau peuvent être complétés avec ces accessoires très utiles à la fois au bureau et à la maison: le magique distributeur de ruban adhésif **Hannibal**, la boîte à compartiments tournants **Multiplor**, les couples de serre-livres **Duplo** et **Gemini**, les cendriers de table **Safe Tray** et **Nox**. Hannibal et Multiplor sont en polymère technique et acier, Duplo et Gemini en acier, Safe Tray en aluminium et polymère technique, Nox en acier inoxydable poli.

Alle Schreibtisch-Sets lassen sich durch diese praktischen Zubehörteile für Büro und zu Hause ergänzen: der magisch Klebefilm-Abroller **Hannibal**, der Behälter mit Drehfächern **Multiplor**, die Buchstützen **Duplo** und **Gemini**, sowie die Tisch-Aschenbecher **Safe Tray** und **Nox**.

Hannibal und Multiplor sind aus Technischem-Polymer und Stahl, Duplo und Gemini aus Stahl, Safe Tray aus Aluminium und Technischem-Polymer, Nox aus poliertem Edelstahl.

Todos los set de escritorio pueden completarse con estos accesorios, muy útiles tanto para la oficina como para el hogar: el mágico dispensador de cinta adhesiva **Hannibal**, el contenedor con bandejas giratorias **Multiplor**, las parejas de apoyalibros **Duplo** y **Gemini**, los ceniceros de mesa **Safe Tray** y **Nox**.

Hannibal y Multiplor en polímero técnico y acero, Duplo y Gemini en acero, Safe Tray en aluminio y polímero técnico, Nox en acero inoxidable pulido.

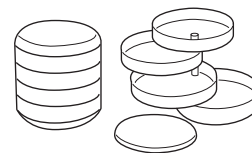

900. MULTIPLOR
design Rino Pirovano, 1977
CONTENITORE CON CASSETTI ROTANTI
ROTATING DESK ORGANIZER
Ø 13 x h 13 cm
dia. 5" x h 5"



701. SAFE TRAY
design Raul Barbieri – Giorgio Marianelli, 1977
POSACENERE DA TAVOLO
TABLE ASHTRAY
13 x 13 x h 5 cm
5" x 5" x h 2"



1690. NOX
design Raul Barbieri, 2003
POSACENERE DA TAVOLO
TABLE ASHTRAY
Ø 28 x h 5 cm
dia. 11" x h 2"

222

TECA

design Enzo Mari
1994



TECA

design Enzo Mari, 1994

Elegante sistema di mensole in alluminio dalla raffinata superficie lievemente ondulata, utilizzabili sia con fissaggio diretto alla parete, che posizionate su montanti per composizioni multiple di libera scelta. Le mensole, disponibili con profondità 15,5 e 22 cm e larghezza 60 e 90 cm, sono anche attrezzabili con coppie di reggilibri.

Mensole e montanti in alluminio estruso anodizzato naturale, reggilibri in acciaio cromato.

Elegant shelving system in aluminium with a refined and slightly wavy surface, it can either be fitted directly onto the wall, or positioned on uprights for multiple compositions of free choice. The shelves, available with depth 15.5 and 22 cm and width 60 and 90 cm, can also be fitted with bookend pairs.

Shelves and uprights in natural anodized extruded aluminium, bookends in chromium plated steel.

Élégant système d'étagères en aluminium avec une surface raffinée légèrement ondulée, utilisable aussi bien à fixer directement au mur, que positionné sur des montants pour compositions multiples de libre choix. Les étagères, disponibles avec profondeur 15,5 et 22 cm et largeur 60 et 90 cm, sont également équipables de couples de serre-livres.

Etagères et montants en aluminium extrudé anodisé naturel, serre-livres en acier chromé.

Elegantes Konsolensystem aus Aluminium, mit raffinierter, leicht welliger Oberfläche, das direkt an der Wand montiert oder auf Träger gesteckt beliebig frei kombiniert werden kann. Erhältlich mit einer Tiefe von 15,5 und 22 cm und einer Breite von 60 und 90 cm, die Konsolen können auch mit optionalen Buchstützen-Paar ausgestattet werden.

Konsolen und Träger aus extrudiertem Aluminium natureloxiert, Buchstützen aus verchromtem Stahl.

Elegante sistema de estantes en aluminio con una refinada superficie ligeramente ondulada, utilizables tanto fijándolos directamente a la pared, como colocándolos sobre montantes para múltiples composiciones libres. Los estantes, disponibles con profundidad 15,5 o 22 cm y anchura 60 o 90 cm, también pueden ser equipados con parejas de apoya libros.

Estantes y montantes en aluminio extruido anodizado natural, apoya libros en acero cromado.

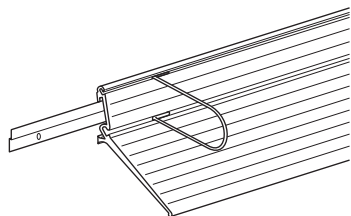
**2620. TECA****MENSOLE****SHELVES**

A1. 60 x 15,5 x h 7,8 cm
23.5" x 6" x h 3"

A2. 90 x 15,5 x h 7,8 cm
35.5" x 6" x h 3"



B1. 60 x 22 x h 8,8 cm
23.5" x 8.5" x h 3.5"

B2. 90 x 22 x h 8,8 cm
35.5" x 8.5" x h 3.5"

**2620. TECA****REGGILIBRI****BOOKSHELVES**

AT. 8 x 11,5 cm
3.25" x 4.75"

BT. 14,5 x 20 cm
5.75" x 8"

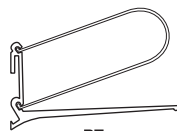
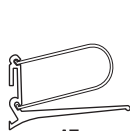

AT.

BT.





TECA

design Enzo Mari, 1994

L'utilizzo su montanti viene effettuato mediante appositi ganci. Le mensole sono posizionabili ad altezze variabili con un passo di 2,5 cm e sono dotate di due diversi punti d'aggancio, di cui uno per i montanti interni di composizioni multiple. Montanti in alluminio estruso anodizzato naturale. Ganci in acciaio inossidabile.

The fitting on uprights is made by means of specific hooks. The shelves can be positioned at different heights with a 2.5 cm tread and are provided with two different attachment points, one of which for the internal uprights of multiple compositions. Uprights in natural anodised extruded aluminium. Hooks in stainless steel.

L'usage sur montants se fait avec des crochets spéciaux. Les étagères peuvent être positionnées à différentes hauteurs avec un pas de 2,5 cm et sont munies de deux points de fixation différents, dont un pour les montants intérieurs des compositions multiples. Montants en aluminium extrudé anodisé naturel. Crochets en acier inoxydable.

Bei Verwendung auf Träger lassen sich die Konsolen mit den passenden Haken auch in verschiedenen Höhen mit einem Abstand von 2,5 cm positionieren. Die Konsolen haben zwei verschiedene Befestigungspunkte, davon einer für die inneren Träger von mehrfachen Kompositionen. Träger aus extrudiertem Aluminium natureloxiert. Haken aus Edelstahl.

Al ser utilizado sobre montantes, mediante ganchos apropiados, los estantes pueden colocarse a alturas variables con un paso de 2,5 cm. Los estantes están dotados de dos puntos de enganche diferentes, uno de los cuales para los montantes internos de composiciones múltiples. Montantes en aluminio extruido anodizado natural. Ganchos en acero inoxidable.

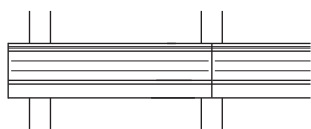
2620. TECA
 MONTANTI
 UPRIGHTS

H1. 4,2 x 1,2 x h 107,5 cm
1,5" x 0,5" x h 42,25"

H2. 4,2 x 1,2 x h 140 cm
1,5" x 0,5" x h 55"

H3. 4,2 x 1,2 x h 172,5 cm
1,5" x 0,5" x h 68"

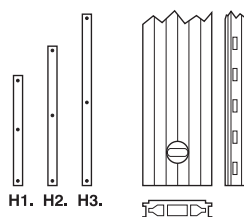

H1. H2. H3.

2620. TECA
 GANCI
 HOOKS



228

TRIESTE

design Enzo Mari
1999



TRIESTE

design Enzo Mari, 1999

Sistema libreria da parete caratterizzato dalle spallette traforate delle mensole, che sono posizionabili su montanti ad altezze variabili con un passo di 5,5 cm. Un sistema molto facile da installare ed estremamente versatile, grazie ai suoi montanti in 3 altezze, alle mensole con 4 profondità e 2 larghezze e ai numerosi componenti disponibili per soddisfare molteplici esigenze.

Mensole, spallette e montanti in acciaio verniciato epoxy texturizzato.

Wall bookcase system characterised by the pierced sides of the shelves, which can be positioned on the uprights at heights varying with a 5.5 cm tread. A very easy to install and extremely versatile system, thanks to its uprights in 3 heights, shelves with 4 depths and 2 widths and the many components available to meet multiple needs.

Shelves, sides and uprights in textured epoxy painted steel.

Système de bibliothèque murale caractérisé par les côtés perforés des étagères, positionnables sur les montants à hauteurs variables avec un pas de 5,5 cm. Un système très facile à installer et extrêmement polyvalent, grâce à ses montants en 3 hauteurs, aux étagères avec 4 profondeurs et 2 largeurs et les nombreux composants disponibles pour répondre aux besoins multiples.

Étagères, côtés et montants en acier verni époxy texturisé.

Bücherregal-Wandsystem, charakterisiert durch Konsolen mit perforierten Seitenstützen, die auf Träger in verschiedenen Höhen mit einem Abstand von 5,5 cm verstellt werden können. Ein sehr einfach zu montierendes und extrem vielseitiges System, mit Trägern in 3 Höhen, Konsolen in 4 Tiefen und 2 Breiten und zahlreichen zusätzlich erhältlichen Komponenten für vielseitige Anforderungen.

Konsolen, Seiten und Träger aus texturiertem, epoxylackiertem Stahl.

Sistema de librería a pared caracterizado por los laterales perforados de los estantes, que pueden colocarse sobre montantes a alturas variables con un paso de 5,5 cm. Sistema muy fácil de instalar y extremadamente versátil, gracias a sus montantes de 3 alturas, a los estantes de 4 profundidades y 2 anchuras y a los numerosos componentes disponibles para satisfacer múltiples necesidades.

Estantes, laterales y montantes en acero pintado epoxy texturizado.

2630. TRIESTE**MONTANTI****UPRIGHTS**

H1. 1,7 x 2,4 x h 82,5 cm
0,75" x 1" x h 32,5"

H2. 1,7 x 2,4 x h 165 cm
0,75" x 1" x h 65"

H3. 1,7 x 2,4 x h 198 cm
0,75" x 1" x h 78"

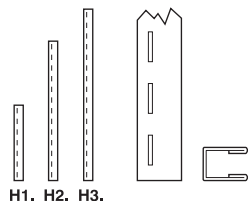
**2630. TRIESTE****MENSOLE****SHELVES**

A1. 60,4 x 16 x h 14 cm
23,75" x 6,25" x h 5,5"

A2. 90,4 x 16 x h 14 cm
35,75" x 6,25" x h 5,5"

B1. 60,4 x 26 x h 14 cm
23,75" x 10,25" x h 5,5"

B2. 90,4 x 26 x h 14 cm
35,75" x 10,25" x h 5,5"

C1. 60,4 x 32 x h 14 cm
23,75" x 12,5" x h 5,5"

C2. 90,4 x 32 x h 14 cm
35,75" x 12,5" x h 5,5"

D1. 60,4 x 42 x h 14 cm
23,75" x 16,5" x h 5,5"

D2. 90,4 x 42 x h 14 cm
35,75" x 16,5" x h 5,5"

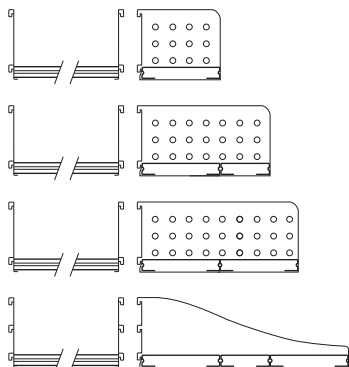



TRIESTE

design Enzo Mari, 1999

Con l'aggiunta di tavoli dalla snella struttura e di mensole con cassetti, Trieste si trasforma in una efficiente workstation. Sono inoltre disponibili piedi decorativi opzionali utilizzabili per il montante centrale delle strutture dei tavoli da 125 o 155 cm o per composizioni con montanti sollevati da terra.

Mensole, spallette, montanti, strutture dei tavoli e piedi decorativi in acciaio verniciato epoxy. Piani dei tavoli in stratificato melaminico antigraffio HPL 10 mm.

With the addition of tables from the slim frame and of shelves with drawers, Trieste is transformed into an efficient workstation. Optional, decorative feet are also available that can be used for the central upright on the 125 or 155 cm table frames or for compositions with uprights raised off the ground.

Shelves, sides, uprights, table frames and decorative feet in textured epoxy painted steel. Table tops in scratch-resistant high pressure melamine laminate HPL 10 mm.

Avec l'ajout de tables à la structure mince et d'étagères avec tiroirs, Trieste se transforme en un efficace poste de travail. Des pieds décoratifs sont également disponibles en option pour le montant central des structures des tables à 125 ou 155 cm ou pour compositions avec montants soulevés du sol.

Etagères, côtés, montants, structures de tables et pieds décoratifs en acier verni époxy texturisé. Plateaux des tables en stratifié mélaminique anti-rayures HPL 10 mm.

Mit zusätzlichen schmalen Tische und Konsolen mit Schubladen verwandelt sich Trieste in eine effiziente Arbeitsstation. Für den mittleren Träger der 125 oder 155 cm breiten Tischgestelle sind optional dekorative FüÙe erhältlich, die auch für oberhalb des Bodens montierte Regale verwendet werden können.

Konsolen, Seiten, Träger, Tischgestelle und dekorative FüÙe aus texturiertem, epoxylackiertem Stahl. Tischplatte aus kratzfestem Hochdruck-SchichtpreÙstoff HPL 10 mm.

Con el complemento de mesas de estructura liviana y de estantes con cajones, Trieste se transforma en una eficaz estación de trabajo. También están disponibles pies decorativos opcionales que pueden utilizarse para el montante central de las estructuras de las mesas de 125 o 155 cm o para composiciones con montantes levantados desde el suelo.

Estantes, laterales, montantes, estructuras de las mesas y pies decorativos en acero pintado epoxy texturizado. Tapas de las mesas en compacto melamínico anti-arañazos HPL 10 mm.

2631. TRIESTE MENSOLA CON CASSETTI SHELF WITH DRAWERS

C1. 60,4 x 32 x h 14 (+5,5) cm
23.75" x 12.5" x h 5.5" (+2")

C2. 90,4 x 32 x h 14 (+5,5) cm
35.75" x 12.5" x h 5.5" (+2")

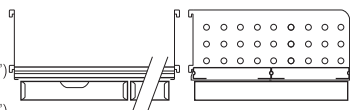

2635. TRIESTE TAVOLI TABLES

T1. 93,5 x 70 x h 73 cm
36.75" x 27.5" x h 28.75"

T2. 125,5 x 70 x h 73 cm
49.5" x 27.5" x h 28.75"

T3. 155,5 x 70 x h 73 cm
61.25" x 27.5" x h 28.75"

T4. 185,5 x 70 x h 73 cm
73" x 27.5" x h 28.75"

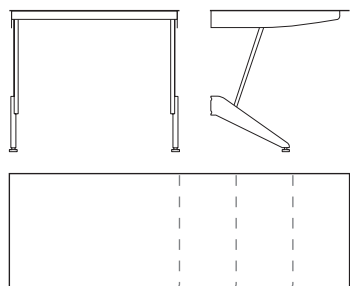

2630.P1. TRIESTE PIEDE DECORATIVO DECORATIVE FOOT

2,5 x 27,5 x h 21 cm
1" x 10.75" x h 8.25"





TRIESTE

design Enzo Mari, 1999

Mensole con barra appendiabiti, mensole inclinate e armadietti alti e bassi con antine scorrevoli completano l'ampia gamma di componenti del sistema Trieste, rendendolo perfetto anche come pratico guardaroba per la casa o versatile espositore per spazi commerciali.

Strutture degli armadietti in acciaio verniciato epoxy texturizzato, barra appendiabiti in acciaio cromato, antine scorrevoli in metacrilato.

Shelves with coat rack, slanted shelves and tall and low cabinets with sliding doors complete the wide range of components of the Trieste System, making it perfect even as a practical wardrobe for the home or a versatile display for commercial spaces.

Cabinet frames in textured epoxy painted steel, coat rails in chromium plated steel, sliding doors in methacrylate.

Etagères porte-vêtements, étagères inclinées et armoires hautes et basses avec portes coulissantes complètent la large gamme de composants du système Trieste, ce qui le rend parfait aussi bien comme garde-robe pratique pour la maison que comme support d'exposition pour les espaces commerciaux.

Structures d'armoires en acier verni époxy texturisé, barre porte-vêtements en acier chromé, portes coulissantes en méthacrylate.

Konsolen mit Kleiderstange, geneigte Konsolen und hohe und niedrige Schränke mit Schiebetüren runden das breite Angebotsspektrum der Trieste-Komponenten ab und machen das System zu einer praktischen Garderobe für zu Hause oder zu einem vielseitigen Aussteller im Gewerbe.

Gestell der Schränke aus texturiertem, epoxylackiertem Stahl. Kleiderstange aus verchromtem Stahl, Schiebetüren aus Methacrylat.

Estantes con barra colgador, estantes inclinados y casilleros altos y bajos con puertas correderas completan la amplia gama de componentes del sistema Trieste y lo convierten también en un perfecto y práctico armario vestidor para el hogar o un versátil expositor para espacios comerciales.

Estructuras de los casilleros en acero pintado epoxy texturizado, barra colgador en acero cromado, puertas correderas en metacrilato.

2633. TRIESTE MENSOLA CON APPENDIABITI CLOTHES HANGING SHELF

D1. 60,4 x 42 x h 14 (+9) cm
23.75" x 16.5" x h 5.5" (+4")

D2. 90,4 x 42 x h 14 (+9) cm
35.75" x 16.5" x h 5.5" (+4")

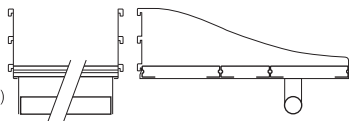

2632. TRIESTE MENSOLA INCLINATA SLANTED SHELF

C1. 60,4 x 26 x h 31 cm
23.75" x 10.25" x 12.25"

C2. 90,4 x 26 x h 31 cm
35.75" x 10.25" x 12.25"

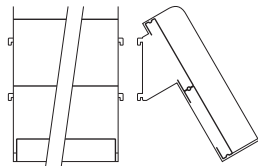

2636. TRIESTE ARMADIETTO ALTO TALL CABINET

90,4 x 32 x h 80 cm
35.75" x 12.5" x h 31.5"

Altezza utile 36,5 + 24 cm
Useful height 14,25" + 9.5"

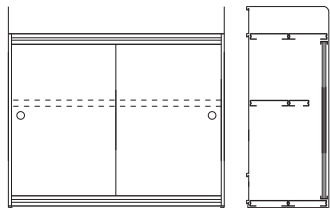

2637. TRIESTE ARMADIETTO BASSO LOW CABINET

90,4 x 42 x h 58 cm
35.75" x 16.5" x h 22.75"

Altezza utile 40 cm
Useful height 15.5"

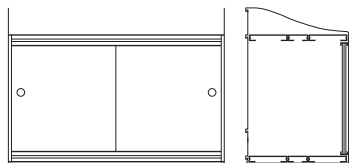



236

BOOX

design Alberto Basaglia – Natalia Rota Nodari
2006

AWARDS

20th BIENNIAL OF INDUSTRIAL DESIGN
2006 – Ljubljana, SLOVENIA

THE CHICAGO ATHENAEUM
2007 – Chicago, U.S.A.

RAT FÜR FORMGEBUNG
2009 – Frankfurt, GERMANY



BOOX

design Alberto Basaglia – Natalia Rota Nodari, 2006

Sistema modulare di contenitori liberamente componibile. Razionale e versatile, con la sua veste elegante e rigorosa si inserisce perfettamente sia in casa come in ufficio e in ambiti commerciali, rispondendo alle più varie esigenze.

Struttura in alluminio estruso, anodizzato naturale o lucidato. Piani in cristallo temperato 6 mm, opaco, bianco o trasparente. Pannelli e antine scorrevoli in metacrilato bianco.

Freely combinable modular container system. Rational and versatile, in its elegant and rigorous role, it fits perfectly both in the home as well as in the office and commercial environments, satisfying a variety of needs.

Frame in extruded aluminium, natural anodized or polished. Shelves in tempered crystal 6 mm, matt, white, or transparent. Panels and sliding doors in white methacrylate.

Système de conteneurs librement modulaire. Rationnel et polyvalent, avec son design élégant et rigoureux, il s'insère parfaitement aussi bien à la maison que dans les environnements de bureaux et commerciaux, répondant aux besoins les plus divers.

Structure en aluminium extrudé, anodisé naturel ou poli. Plateaux en cristal trempé 6 mm, dépoli, blanc, ou transparent. Panneaux et portes coulissantes en méthacrylate blanc.

Modulares Behältersystem, das sich individuell zusammenstellen lässt. Rational und vielseitig, mit elegantem und strengem Aussehen integriert es sich perfekt zu Hause, im Büro oder in Geschäften für verschiedenste Bedürfnisse.

Rahmen aus extrudiertem Aluminium, natureloxiert oder poliert. Fachböden aus Hart-Kristallglas 6 mm, matt, weiß oder transparent. Paneele und Türen aus weißem Methacrylat.

Sistema modular de contenedores libremente componible. Racional y versátil, con su apariencia elegante y rigurosa encaja perfectamente tanto en el hogar como en la oficina o en entornos comerciales, respondiendo a las más diversas necesidades.

Estructura en aluminio extruido, anodizado natural o pulido. Estantes en cristal templado 6 mm, matizado, blanco, o transparente. Paneles y puertas correderas en metacrilato blanco.

2700. BOOX

MODULO BASE

BASIC UNIT

60-90 x 45 x h 50 (+7) cm

23.5-35.5" x 17.75" x h 19.75" (+2.5")

Altezza utile 40 cm

Useful height 15.75"

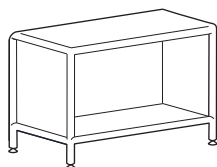
**2700.G0. BOOX**

ANTINE SCORREVOLI

SLIDING DOORS

90 x h 40 cm

35.5" x h 15.75"

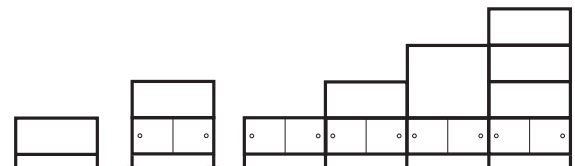
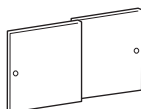







BOOX DOPPIO

design Alberto Basaglia – Natalia Rota Nodari, 2007

Il sistema Boox è disponibile anche in una versione a doppia profondità che consente l'utilizzo da entrambi i lati, particolarmente adatta per biblioteche e librerie.

Struttura in alluminio estruso anodizzato naturale o lucidato. Piani in cristallo temperato 6 mm, opaco, bianco o trasparente. Pannelli e antine scorrevoli in metacrilato bianco.

The Boox system is also available in a double-depth version allowing its use on both sides, particularly suitable for libraries and bookshops. Frame in natural anodised extruded aluminium. Shelves in tempered crystal 6 mm, matt, white, or transparent. Panels and sliding doors in white methacrylate.

Le système Boox est également disponible dans une version à double profondeur qui permet l'utilisation des deux côtés, particulièrement adapté aux bibliothèques et librairies.

Structure en aluminium extrudé anodisé naturel ou poli. Plateaux en cristal trempé 6 mm, dépoli, blanc, ou transparent. Panneaux et portes coulissantes en méthacrylate blanc.

Das Boox-System ist auch mit doppelter Tiefe erhältlich, was die beidseitige Nutzung ermöglicht, weshalb es sich besonders für Bibliotheken und Buchhandlungen eignet.

Rahmen aus extrudiertem Aluminium, natureloxiert oder poliert. Fachböden aus Hart-Kristallglas 6 mm, matt, weiß oder transparent. Paneele und Türen aus weißem Methacrylat.

El sistema Boox también está disponible en una versión de profundidad doble que permite su uso por ambos lados, especialmente adecuada para bibliotecas y librerías.

Estructura en aluminio extruido anodizado natural o pulido. Estantes en cristal templado 6 mm, matizado, blanco, o transparente. Paneles y puertas correderas en metacrilato blanco.

2702. BOOX DOPPIO

MODULO BASE

BASIC UNIT

60-90 x 82 x h 50 (+7) cm
23.5-35.5" x 32.25" x h 19.75" (+2.5")

Altezza utile 40 cm
Useful height 15.75"

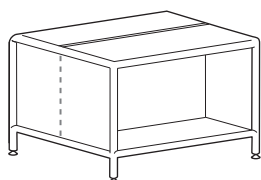

2700.G0. BOOX

ANTINE SCORREVOLI

SLIDING DOORS

90 x h 40 cm
35.5" x h 15.75"

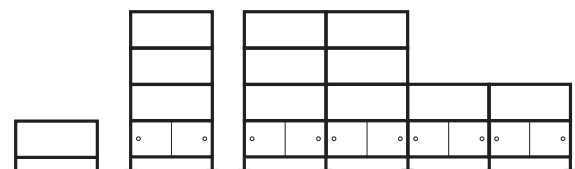
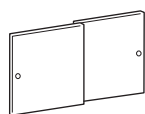



244

QUINTA

design Raul Barbieri
2011

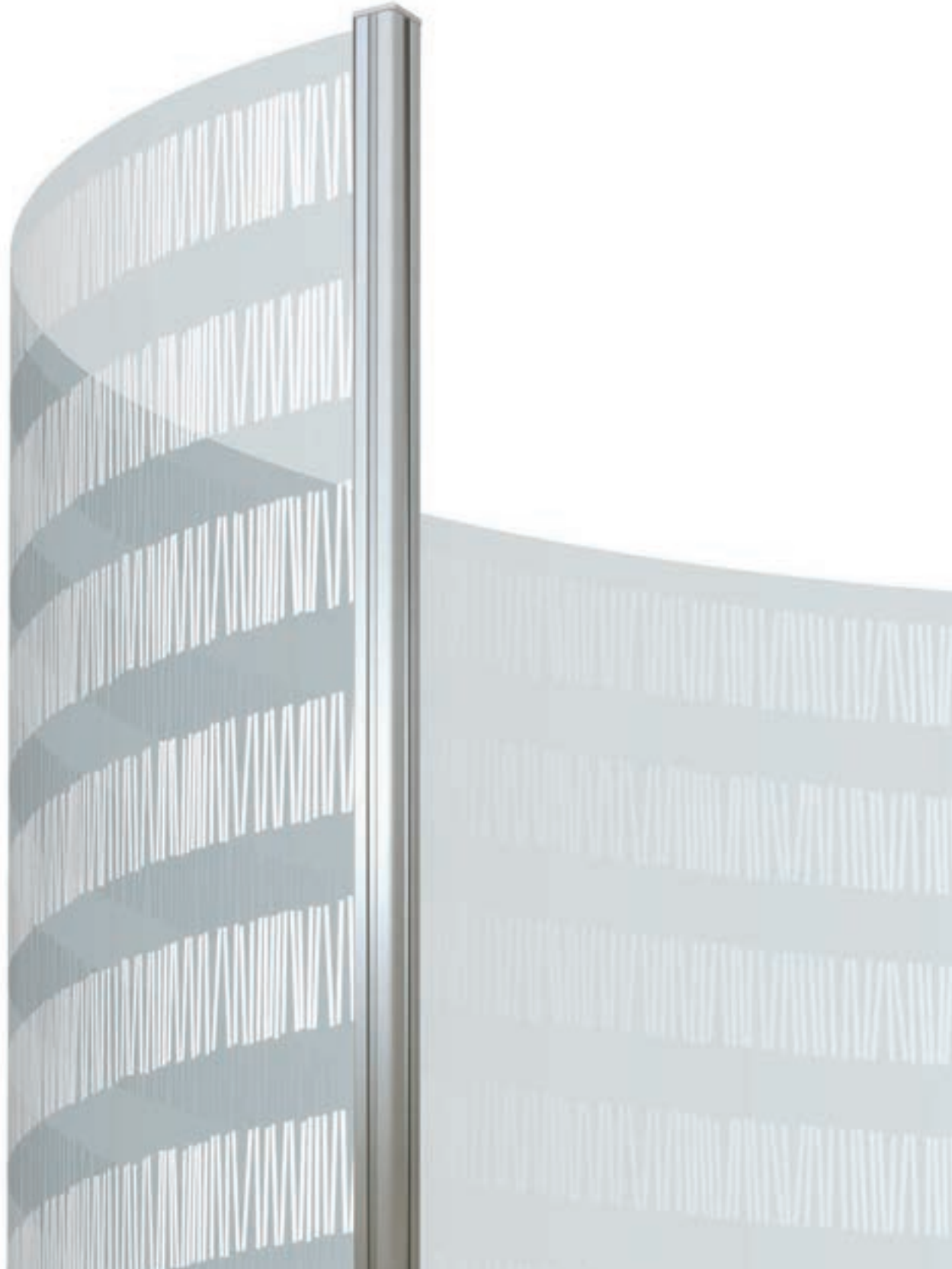

QUINTA

design Raul Barbieri

Versatile sistema divisorio modulare, composto da pannelli flessibili in policarbonato traslucido che consentono di realizzare pareti continue sia curve che rettilinee, grazie ad un sistema brevettato di aggancio rapido ai montanti di sostegno in alluminio. Pannelli in policarbonato traslucido flame retardant texturizzato. Montanti in alluminio estruso anodizzato naturale con basi in acciaio verniciato alluminio.

Versatile modular partition system, made up of flexible panels in translucent polycarbonate that allows for the installation of continuous partitions, both curved and straight, thanks to a patented system for the rapid fastening to the aluminium supporting uprights.

Panels in translucent, textured polycarbonate flame retardant. Uprights in natural anodised extruded aluminium with steel bases aluminium painted.

Système polyvalent de partition modulaire, composé de panneaux flexibles en polycarbonate translucide qui permettent la construction de parois continues courbes ou droites, grâce à un système breveté pour le couplage rapide sur les montants de support en aluminium.

Panneaux en polycarbonate translucide flame retardant texturisé. Montants en aluminium extrudé anodisé naturel avec bases en acier verni aluminium.

Modulares Trennwandsystem, bestehend aus flexiblen Paneelen aus durchscheinendem Polycarbonat, mit denen sich sowohl gebogene, als auch gerade Abtrennungen an den Aluminium Ständern erstellen lassen, dank eines patentierten Schnellbefestigungssystems.

Paneele aus durchscheinendem Polycarbonat schwer entflammbar, texturisiert. Ständer aus extrudiertem Aluminium naturaleloxiiert, mit Sockel aus Stahl silberfarbig lackiert.

Versátil sistema divisorio modular, compuesto por paneles flexibles de policarbonato translúcido que permiten construir paredes continuas tanto en curva como rectilíneas, gracias a un sistema patentado de enganche rápido a los montantes de soporte en aluminio.

Paneles en policarbonato translúcido flame retardant texturizado. Montantes en aluminio extruido anodizado natural con bases en acero pintado aluminio.

2600-1. QUINTA
MODULO BASE E PROLUNGA
BASIC UNIT AND EXTENSION
100 x h 180 cm (senza basi)
39.5" x h 71" (without bases)
PANNELLO / PANEL
97 x h 165 cm
38.25" x h 65"

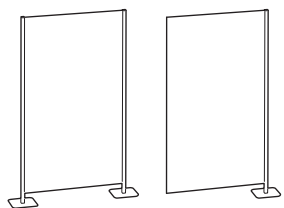

2600.

2601.

2604-5. QUINTA
MODULO BASE E PROLUNGA
BASIC UNIT AND EXTENSION
100 x h 140 cm (senza basi)
39.5" x h 55" (without bases)
PANNELLO / PANEL
97 x h 125 cm
38.25" x h 49.25"

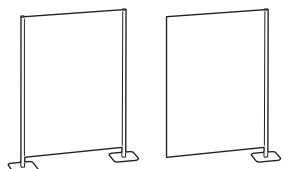

2604.

2605.

BASI / BASES
Standard 30 x 30 cm
11.75" x 11.75"
Parete / Wall 30 x 17 cm
11.75" x 6.75"

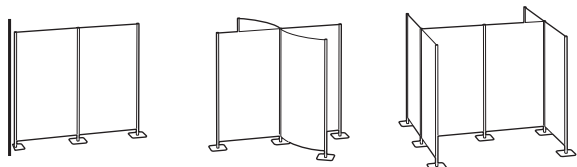



QUINTA

design Raul Barbieri

Quinta è il sistema ideale per la realizzazione di allestimenti per qualunque evento perché offre la possibilità di variare con estrema facilità i pannelli, disponibili neutri o nelle grafiche "Tela" e "Barre". Su richiesta i pannelli possono anche essere personalizzati con la stampa in quadricromia di qualunque soggetto.

Pannelli in policarbonato traslucido flame retardant texturizzato. Montanti in alluminio estruso anodizzato naturale con basi in acciaio verniciato alluminio.

Quinta is the ideal system for building stands for any event because it makes it possible to change with extreme ease the panels, available in neutral or in the "Tela" and "Barre" graphics, but which on demand can also be customised with the four colour printing of any subject.

Panels in translucent, textured polycarbonate flame retardant. Uprights in natural anodised extruded aluminium with steel bases aluminium painted.

Quinta est le système idéal pour la construction de stands pour tout événement, car il offre la possibilité de varier avec extrême facilité les panneaux disponibles neutres ou dans les graphiques "Tela" et "Barre".

A la demande, les panneaux peuvent également être personnalisés avec l'impression de tout motif en quadrichromie. Panneaux en polycarbonate translucide flame retardant texturisé. Montants en aluminium extrudé anodisé naturel avec bases en acier verni aluminium.

Quinta ist das ideale System für den Bau zur Vorbereitung auf Veranstaltungen, weil es die Möglichkeit bietet, die Trennwände mit extremer Leichtigkeit zu ändern. Diese sind neutral oder mit den Graphiken „Tela“ und „Barre“ erhältlich, aber auf Wunsch auch im Vierfarbdruck personalisiert werden können.

Panele aus durchscheinendem Polycarbonat schwer entflammbar, texturisiert. Ständer aus extrudiertem Aluminium naturaleloxiert, mit Sockel aus Stahl silberfarbig lackiert.

Quinta es el sistema ideal para la construcción de stands para cualquier evento, ya que ofrece la posibilidad de cambiar con extrema facilidad los paneles, que están disponibles en color neutro o con los motivos "Tela" y "Barre". Bajo pedido, los estantes también pueden personalizarse mediante la impresión de cualquier imagen en quatricromía.

Paneles en policarbonato translúcido flame retardant texturizado. Montantes en aluminio extruido anodizado natural con bases en acero pintado aluminio.

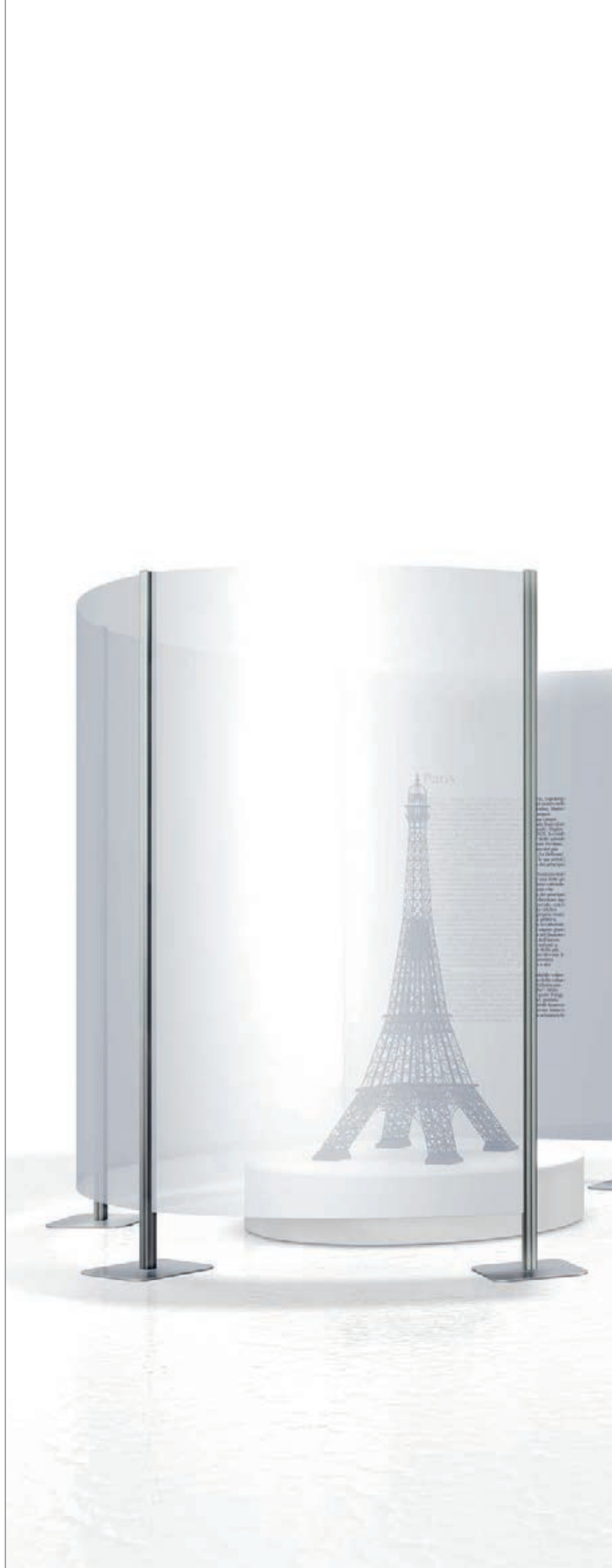

00.00

00.B2 **BARRE**00.T2 **TELA**



250

ABITACOLO

design Bruno Munari
1971



XI COMPASSO D'ORO

1979 – Milano, ITALY



ABITACOLO

design Bruno Munari

Mitico modulo abitabile, creato da Bruno Munari e premiato con il Compasso d'Oro nel 1979. Si monta con 8 viti e in uno spazio minimo soddisfa le principali esigenze dei ragazzi: sognare, ascoltare la musica, leggere, giocare, studiare e custodire gli oggetti preferiti.

Struttura, mensole e cestelli in acciaio verniciato epoxy, tavolino pieghevole in laminato melaminico, ganci in acciaio cromato. Materasso 190x80 cm non incluso.

Mythical living unit, created by Bruno Munari and awarded the Compasso d'Oro in 1979. It is assembled with 8 screws and, within a limited space, satisfies all the basic needs of young people: dreaming, listening to music, reading, playing, studying and storing all the favourite things.

Frame, shelves and baskets in epoxy painted steel, folding melamine laminate table, chromium plated steel hooks. 190x80 cm mattress not included.

Module habitable mythique, créé par Bruno Munari et récompensé par le Compas d'Or en 1979. Se monte avec 8 vis et en un minimum d'espace répond aux principales exigences des jeunes: rêver, écouter de la musique, lire, jouer, étudier et garder les objets préférés.

Structure, étagères et paniers en acier verni époxy, tablette repliable en mélaminé, crochets en acier chromé. Matelas 190x80 cm non inclus.

Sagenumwobenes Wohnmodul des Designers Bruno Munari, das 1979 mit dem Compasso d'Oro ausgezeichnet wurde. Die Montage mit 8 Schrauben auf minimalem Raum erfüllt alle grundlegenden Bedürfnisse von Jugendlichen: träumen, Musik anzuhören, lesen, spielen, studieren und alle Lieblingssachen beherbergen zu können.

Gestell, Konsolen, Körben aus epoxy-lackiertem Stahl, Kipptisch aus Melamin Laminat, Haken aus verchromtem Stahl. Matratze 190x80 cm nicht inbegriffen.

Mítico módulo habitable creado por Bruno Munari y premiado con el Compasso d'Oro en 1979. Se monta con 8 tornillos y en un espacio mínimo satisface las principales exigencias de los jóvenes: soñar, escuchar música, leer, jugar, estudiar y guardar los objetos favoritos.

Estructura, estantes y cestas en acero pintado epoxy, mesita plegable en tablero laminado melamínico, ganchos en acero cromado. Colchón 190x80 cm no incluido.

2401. ABITACOLO STRUTTURA DEL LETTO BED FRAME

194 x 83 x h 206 cm
76.5" x 32.5" x h 81"

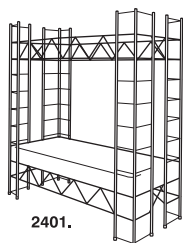

2401.

2401.ME ABITACOLO MENSOLA / SHELF

78 x 20 cm
30.75" x 8"



2401.ME



2401.CE

2401.CE ABITACOLO CESTELLO / BASKET

33 x 22 x h 20 cm
13" x 8.5" x h 8"

2401.TA ABITACOLO TAVOLINO / TABLE

75 x 45 cm
29.5" x 17.75"

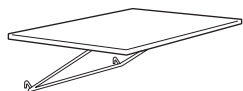

2401.TA



2401.GA

2401.GA ABITACOLO 10 GANCI / 10 HOOKS



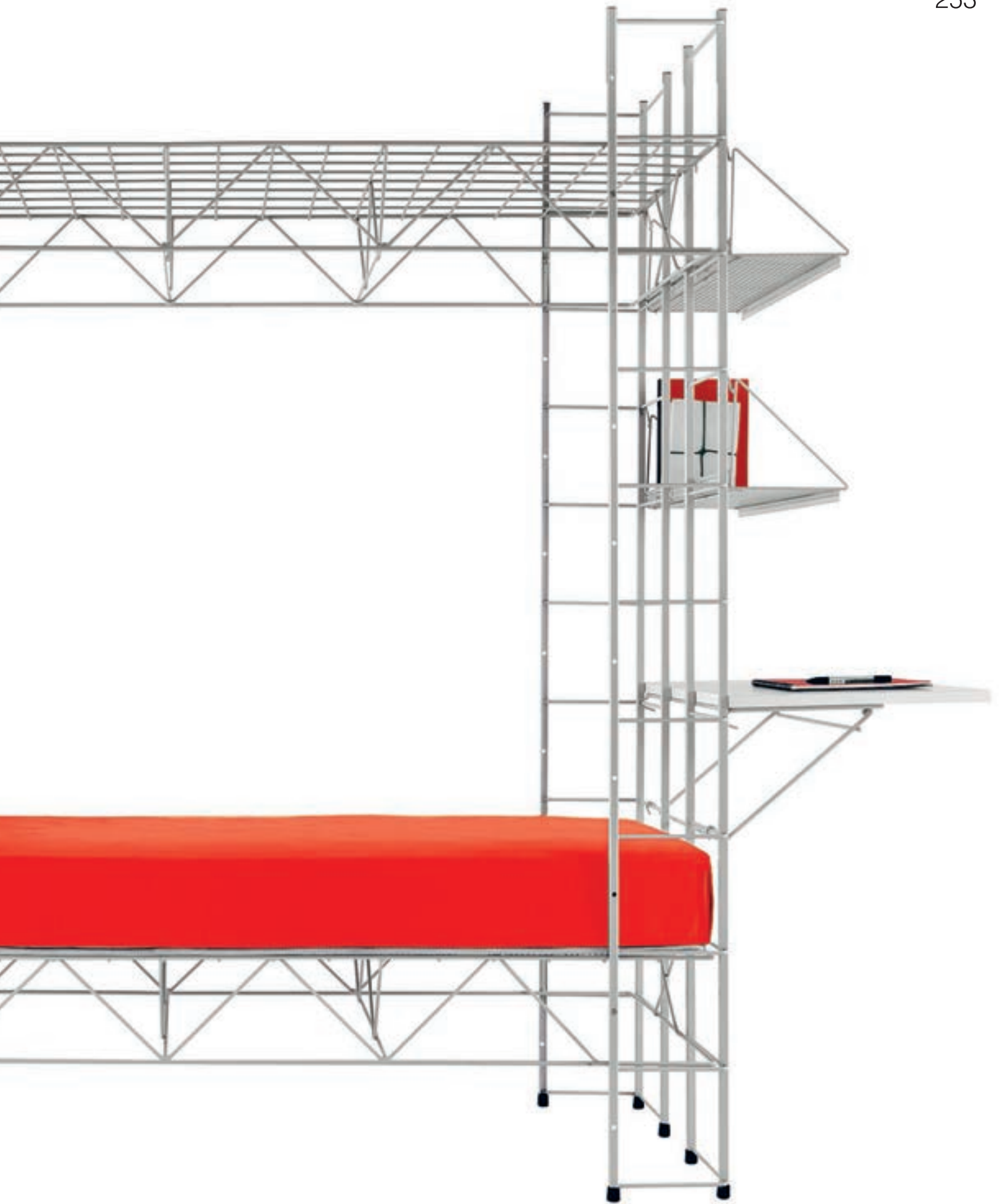





256

BANCO LIGHT

design Raul Barbieri
2001

AWARDS

NEOCON 2001 (Best of Show)
2001 – Chicago, U.S.A.

I.D. Magazine (Honorable Mention)
2002 – New York, U.S.A.



BANCO LIGHT

design Raul Barbieri, 2001

Agile ed elegante scrittoio per computer dotato di un ripiano inferiore ideale per collocare la stampante e di due rotelline posteriori per facilitarne gli spostamenti. Perfetto per la casa e ideale per situazioni di uffici temporanei, può essere corredato di un vassoio scorrevole per riporre la piccola cancelleria.

Struttura in alluminio anodizzato naturale. Piani in cristallo temperato opaco 8 mm, o in stratificato melaminico antigraffio HPL 8 mm. Vassoio scorrevole in acciaio verniciato alluminio.

Nimble and elegant writing desk for computers, fitted with a perfect bottom shelf for holding the printer and two rear castors for easy movement. Perfect for the home and ideal for temporary offices, it can be equipped with a sliding tray to store small stationery.

Natural anodised aluminium frame. Shelves in matt tempered crystal 8 mm, or in scratch-resistant high pressure melamine laminate HPL 8 mm. Sliding tray in steel aluminium painted.

Ecritoire pour ordinateur agile et élégant, équipé d'un plateau inférieur parfait pour placer l'imprimante et de deux roulettes arrières pour un déplacement facile. Parfait pour la maison et idéal pour les situations de bureaux temporaires, peut être équipé d'un plateau coulissant pour la petite papeterie.

Structure en aluminium anodisé naturel. Plateaux en cristal trempé dépoli 8 mm, ou en stratifié mélaminique anti-rayures HPL 8 mm. Plateau coulissant en acier verni aluminium.

Wendiger und eleganter Computer-Tisch mit Ablagefläche für den Drucker und zwei Hinterrädern für einfaches Hin- und Herschieben. Ideal für zu Hause und temporäre Arbeitsplätze in Büros, kann auch mit einer Schiebeablage für Schreibutensilien ausgestattet werden.

Gestell aus Aluminium natureloxiert. Fachböden aus Hart-Kristallglas 8 mm, matt, oder aus kratzfestem Hochdruck-Schichtpreßstoff HPL 8 mm. Schiebeablage aus Stahl alufarbig lackiert.

Ágil y elegante escritorio para ordenador dotado de un estante inferior perfecto para colocar la impresora y de dos ruedas traseras para facilitar su desplazamiento. Perfecto para el hogar e ideal para situaciones de oficinas temporales, se le puede añadir una bandeja corredera para guardar el material de papelería.

Estructura en aluminio anodizado natural. Estantes en cristal templado matizado 8 mm o en compacto melamínico anti-arañazos HPL 8 mm. Bandeja corredera en acero pintado aluminio.

2021. BANCO LIGHT
SCRITTOIO PER COMPUTER
COMPUTER DESK

88 x 63 x h 73 cm
34.75" x 24.75" x h 28.75"

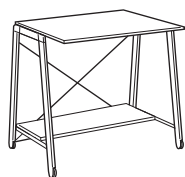

201.
VASSOIO ESTRAIBILE
PULL-OUT TRAY

77,5 x 31,5 x h 3 cm
30.5" x 12.5" x h 1.25"





260

JOLLY

design Alberto Basaglia – Natalia Rota Nodari
2011



JOLLY

design Alberto Basaglia – Natalia Rota Nodari, 2011

Armadietto su ruote con antine scorrevoli. Capiente ed elegante, è perfetto accanto alla scrivania in ufficio o a casa come mobiletto per Hi-Fi.

Struttura in alluminio estruso, anodizzato naturale o lucidato. Piani in cristallo temperato 6 mm, superiore bianco, inferiore opaco. Pannelli e antine scorrevoli in metacrilato bianco.

Cabinet on castors with sliding doors. Roomy and elegant, it is perfect next to the desk in an office or as Hi-Fi cabinet at home.

Frame in extruded aluminium, natural anodised or polished. Shelves in tempered crystal 6 mm, top white, lower matt. Panels and sliding doors in white methacrylate.

Conteneur sur roulettes avec portes coulissantes. Spacieux et élégant, il est parfait à côté du bureau au travail ou à la maison comme meuble pour la Hi-Fi.

Structure en aluminium extrudé, anodisé naturel ou poli. Plateaux en cristal trempé 6 mm, supérieur blanc, inférieur dépoli. Panneaux et portes coulissantes en méthacrylate blanc.

Rollschrank mit Schiebetüren. Geräumig und elegant, passt er perfekt neben den Schreibtisch im Büro, aber zu Hause auch als HiFi-Möbel.

Rahmen aus extrudiertem Aluminium, natureloxiert oder poliert. Fachböden aus Hart-Kristallglas 6 mm, Obere weiß, Untere matt. Seitenpaneelen und Schiebetüren aus weißem Methacrylat.

Contenedor sobre ruedas con puertas correderas. Espacioso y elegante, es perfecto junto al escritorio en la oficina o en el hogar como mueble para equipos de música Hi-Fi.

Estructura en aluminio extruido, anodizado natural o pulido. Estantes en cristal templado 6 mm, superior blanco, inferior matizado. Paneles y puertas correderas en metacrilato blanco.



2753-63. JOLLY
ARMADIETTO SU RUOTE
CABINET ON CASTORS
95 x 45 x h 66 cm
37.5" x 17.75" x h 26"

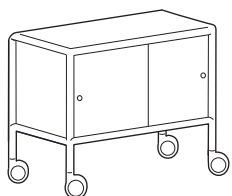



264

TENDER

design Raul Barbieri
1998

AWARDS

THE CHICAGO ATHENAEUM
1999 – Chicago, U.S.A.

ADI DESIGN INDEX 98
2000 – Milano, ITALY



TENDER

design Raul Barbieri, 1998

Carrello con eleganti vassoi dalla morbida linea classica. Agile e robusto, può trasportare senza sforzo fino a 12 coperti e 24 bicchieri: l'aiuto ideale per gli inviti a pranzo.

È disponibile anche il singolo vassoio Tender Tray, identico e perfettamente sovrapponibile a quelli del carrello.

Struttura in acciaio cromato, vassoi in polimero tecnico traslucido o verniciato alluminio.

Trolley with elegant soft classic line trays. Nimble and sturdy, it can effortlessly carry up to 12 plates and 24 glasses: the ideal help for lunch guests.

The single Tender Tray, which is identical and perfectly superimposable on those of the trolley, is also available.

Chromium plated steel frame, trays in engineering polymer, translucent or aluminium painted.

Chariot caractérisé par des plateaux élégants avec une douce ligne classique. Agile et résistant, il peut transporter facilement jusqu'à 12 couverts et 24 verres: l'aide idéale lors des invitations à dîner.

Le plateau Tender Tray est aussi disponible seul, identique et parfaitement superposable à ceux du chariot.

Structure en acier chromé, plateaux en polymère technique translucide ou verni aluminium.

Servierwagen mit eleganten Tablett und einer weichen, klassischen Linienführung. Wendig und robust, kann bis zu 12 Gedecke und 24 Gläser transportieren: Ideale Servierhilfe, wenn Gäste eingeladen wurden.

Ebenfalls erhältlich ist das Einzeltablett Tender Tray, das genau zu den Tablett des Servierwagens passt und auf diese gestellt werden kann.

Gestell aus verchromtem Stahl. Tablett aus Technischem Polymer, durchscheinend-weiss oder alufarbig lackiert.

Carrito caracterizado por elegantes bandejas con una suave línea clásica. Ágil y robusto, puede transportar sin esfuerzo hasta 12 platos y 24 vasos: el asistente ideal para las comidas con invitados.

También está disponible la bandeja individual Tender Tray, idéntica y perfectamente apilable sobre las del carrito.

Estructura en acero cromado, bandejas en polímero técnico translúcido o pintado aluminio.

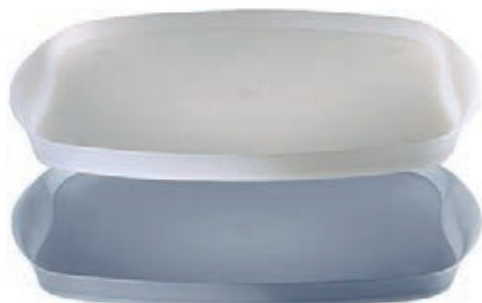
**2299. TENDER**

CARRELLO

TROLLEY

62 x 46 x h 72 cm
24.5" x 18" x h 28.25"**2301. TENDER**

VASSOIO

TRAY

62 x 46 x h 5 cm
24.5" x 18" x h 2"



268

T-TAP

design Donato D'urbino – Paolo Lomazzi
2006



T-TAP

design Donato D'Urbino – Paolo Lomazzi, 2006

Carrello pieghevole con vassoi in alluminio anodizzato. Leggero, resistente e praticissimo, una volta chiuso si regge magicamente in piedi da solo grazie a un sistema estremamente semplice, occupando solo 19 cm in profondità.

Struttura in acciaio cromato, vassoi in alluminio estruso anodizzato naturale.

Folding trolley with anodised aluminium trays. Lightweight, strong and handy, when closed it magically stands on its own thanks to a very simple system, occupying only 19 cm in depth. Chromium plated steel frame, natural anodised extruded aluminium trays.

Chariot repliable avec plateaux en aluminium anodisé. Léger, robuste et très pratique, une fois fermé, il se maintient magiquement debout seul grâce à un système très simple, occupant seulement 19 cm d'épaisseur.

Structure en acier chromé, plateaux en aluminium extrudé anodisé naturel.

Zusammenklappbarer Servierwagen mit Tablett aus natureloxiertem Aluminium. Leicht, robust und äußerst praktisch, bleibt er dank seines einfachen Klappsystems von alleine stehen und nimmt in der Tiefe nur 19 cm Platz ein.

Gestell aus verchromtem Stahl, Tablett aus extrudiertem Aluminium natureloxiert.

Carrito plegable con bandejas en aluminio anodizado. Ligero, resistente y muy práctico, cuando se cierra se mantiene en pie como por magia gracias a un sistema muy sencillo, ocupando solo 19 cm de profundidad.

Estructura en acero cromado, bandejas en aluminio extruido anodizado natural.



2305. T-TAP
CARRELLO PIEGHEVOLE
FOLDING TROLLEY
65 x 50 x h 82,5 cm
25,5" x 19,75" x h 32,5"





272

CANTINA PRESS

design Enzo Mari
2000



CANTINA PRESS

design Enzo Mari, 2000

Cantina è un portabottiglie impilabile dal design minimale, che può contenere con eleganza e praticità fino a 12 bottiglie. È la perfetta soluzione per riporre qualsiasi tipo di bottiglia in uno spazio contenuto e facilmente accessibile.

Press, elegante e capiente ma non ingombrante, è l'ideale per accogliere i giornali e le riviste a fianco della poltrona di casa o nelle sale d'aspetto di studi ed uffici.

Tondino d'acciaio cromato.

Cantina is a stackable bottle holder with a minimalist design, which can elegantly hold up to 12 bottles. It is the perfect solution for storing any kind of bottle in a small and easily accessible space.

Press, stylish and roomy but not bulky, is ideal for storing newspapers and magazines next to the armchair at home or in the waiting rooms of firms and offices.

Chromium plated steel rod.

Cantina est un porte-bouteilles empilable au design minimaliste, qui peut accueillir jusqu'à 12 bouteilles avec élégance et praticité. C'est la solution idéale pour stocker tout type de bouteille dans un petit espace facilement accessible.

Press, élégant et spacieux mais non encombrant, est idéal pour accueillir les journaux et les magazines à côté d'un fauteuil à la maison ou dans les salles d'attente des cabinets privés et des bureaux.

Tige en acier chromé.

Cantina ist ein stapelbares Weinregal im minimalistischen Design, das mit praktischer Eleganz bis zu 12 Flaschen aufnehmen kann. Es ist die perfekte Lösung, Flaschen jeder Art einfach zugänglich auf begrenztem Raum zu lagern.

Press ist der stilvolle und aufnahmefähige, aber nicht sperrige Zeitungsständer, der zu Hause neben den Sessel oder in Wartezimmern passt.

Verchromter Rundrohrstahl.

Cantina es un botellero apilable de diseño minimalista que puede contener con elegancia y funcionalidad hasta 12 botellas. Es la solución perfecta para almacenar cualquier tipo de botella en un espacio pequeño y de fácil acceso.

Press, elegante y espacioso sin ser voluminoso, resulta ideal para almacenar periódicos y revistas junto al sillón de casa o en las salas de espera de estudios y oficinas.

Barilla de acero cromado.

2320. CANTINA
PORTABOTTIGLIE IMPILABILE
PER 12 BOTTIGLIE

STACKABLE BOTTLE-RACK
FOR 12 BOTTLES

33 x 24 x h 42 cm
13" x 9.5" x h 16.5"

2322. PRESS
PORTARIVISTE
MAGAZINE-RACK

37 x 16 x h 38 cm
14.5" x 6.5" x h 15"

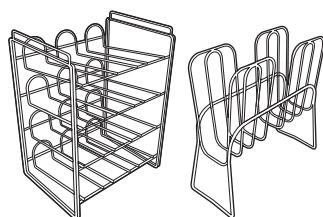

2320.

2322.





OROLOGI DA PARETE WALL CLOCKS

design Raul Barbieri – Giorgio Marianelli

AWARDS

CONTRATTEMPO

12th BIENNIAL OF INDUSTRIAL DESIGN
1988 – Ljubljana, SLOVENIA

DESIGN PLUS
1988 – Frankfurt, GERMANY

APPUNTAMENTO

FORM '95
1995 – Frankfurt, GERMANY



CONTRATTEMPO APPUNTAMENTO

design Raul Barbieri – Giorgio Marianelli

Una storica coppia di orologi a pendolo da parete, veri e propri classici contemporanei che continuano a stupire e a regalare buon umore con il loro disco che fluttua instancabile, come sospeso magicamente. Ai due modelli classici di Appuntamento, si sono aggiunte nuove versioni intriganti e ironiche. Cassa e quadrante in polimero tecnico, movimento al quarzo.

A historical pair of pendulum clocks, true contemporary classics that continue to amaze and bring pleasure with their disk tirelessly floating as though magically suspended. The two classic Appuntamento models have been added to with new, intriguing and ironic versions.

Case and face in engineering polymer, quartz movement.

Un historique couple de pendules murales, deux véritables classiques contemporains qui continuent d'étonner et distiller bonne humeur avec leur disque qui flotte, infatigable, comme suspendu par magie. Aux deux modèles classiques d'Appuntamento viennent s'ajouter de nouvelles versions intrigantes et ironiques.

Corps et cadran en polymère technique, mouvement à quartz.

Historisches Paar von Wand-Pendeluhr, wahre zeitgenössische Klassiker, die mit ihrer Scheibe, die sich wie von Zauberhand bewegt, einfach gute Laune verbreiten. Zu den beiden klassischen Modellen von Appuntamento kommen neue, lustige, faszinierende Versionen.

Gehäuse und Zifferblatt aus Technischem-Polymer, Quarzwerk.

Histórica pareja de relojes de pared con péndulo, verdaderos clásicos contemporáneos que siguen sorprendiendo y alegrando con su disco que fluctúa incansable, como suspendido por arte de magia. Además de los dos modelos clásicos de Appuntamento, se han añadido nuevas versiones, intrigantes e irónicas.

Cuerpo y esfera en polímero técnico, movimiento de cuarzo.



987.00.42 CONTRATTEMPO



987.00.44 CONTRATTEMPO



987.AN.AN CONTRATTEMPO

987. CONTRATTEMPO

design Raul Barbieri – Giorgio Marianelli, 1987

OROLOGIO A PENDOLO DA PARETE

PENDULUM WALL CLOCK

Ø 45 x 5,5 cm
dia. 17.75" x 2.25"

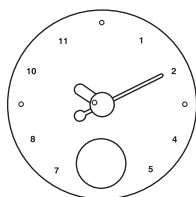

988. APPUNTAMENTO

design Raul Barbieri, 1995

OROLOGIO A PENDOLO DA PARETE

PENDULUM WALL CLOCK

Ø 45 x 5,5 cm
dia. 17.75" x 2.25"

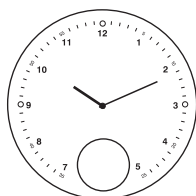



988.00.01 APPUNTAMENTO
GIORNO



988.00.03 APPUNTAMENTO
NOTTE



988.00.15 APPUNTAMENTO
BUBBLE



988.00.16 APPUNTAMENTO
MILLEUNANOTTE



988.00.17 APPUNTAMENTO
PRIMAVERA



988.00.17 APPUNTAMENTO
INVERNO



988.00.13 APPUNTAMENTO
GIOCOLIERE



988.00.14 APPUNTAMENTO
SCACCOMATTO



988.00.11 APPUNTAMENTO
DESIGN



988.00.12 APPUNTAMENTO
ITALY

ORARIO ZERO

design Raul Barbieri – Giorgio Marianelli

Orario, ispirato agli iconici orologi delle stazioni ferroviarie svizzere, è l'orologio da parete ideale per eleganti sale d'aspetto ed uffici direzionali. Cassa e quadrante in polimeri tecnici, movimento al quarzo. Orario Inox con quadrante in acciaio inossidabile satinato.

Zero, adatto a ogni tipo d'ambiente, è caratterizzato dal disegno morbido della cassa e dall'originale quadrante con i minuti evidenziati da una punteggiatura di gocce in rilievo. Cassa e quadrante in polimeri tecnici, vetro in acrilico, movimento al quarzo.

Orario, inspired by the iconic Swiss railway station clocks, is the perfect wall clock for elegant waiting rooms and executive offices. Case and face in engineering polymer, quartz movement. Orario Inox with face in brushed stainless steel.

Zero, suitable for every type of environment, features a soft design case and an original face with the minutes highlighted by a punctuation of beaded drops. Case and face in engineering polymers, acrylic glass, quartz movement.

Orario, inspirée par les horloges emblématiques des gares suisses, est l'horloge murale idéale pour salles d'attente élégantes et bureaux de direction. Corps et cadran en polymères techniques, mouvement à quartz. Orario Inox avec cadran en acier inoxydable satiné.

Zero, adapté à tout type d'environnement, est caractérisé par le design souple du corps et par le cadran original avec les minutes mis en évidence par une ponctuation de gouttes perlées. Corps et cadran en polymères techniques, verre en acrylique, mouvement à quartz.

Orario, inspiriert von den symbolträchtigen Normaluhren der Schweizer Bahnhöfe, ist die ideale Wanduhr für elegante Wartezimmer und Chefbüros. Gehäuse und Zifferblatt aus Technischem-Polymer, Quarzwerk. Orario Inox mit Zifferblatt aus satiniertem Edelstahl.

Zero, geeignet für jede Art von Umgebung, zeichnet sich durch das weiche Design des Gehäuses und dem originellen Zifferblatt aus, bei dem die Minuten durch hervorgehobene Tropfenpunkte angegeben sind. Gehäuse und Zifferblatt aus Technischem-Polymer, Acrylglas, Quarzwerk.

Orario, inspirado en los icónicos relojes de las estaciones de ferrocarril suizas, es el reloj de pared perfecto para elegantes salas de espera y oficinas de dirección. Cuerpo y esfera en polímero técnico, movimiento de cuarzo. Orario Inox con esfera en acero inoxidable satinado.

Zero, adecuado para cualquier tipo de entorno, se caracteriza por el diseño suave de la caja y una esfera original con los minutos marcados por un punteado de gotas en relieve. Cuerpo y esfera en polímero técnico, vidrio en acrílico, movimiento de cuarzo.



986.00.01 ORARIO



986.AN.AN ORARIO



986.X0.X0 ORARIO INOX



980.00.01 ZERO



980.AN.AN ZERO

986. ORARIO
design Raul Barbieri, 1998
OROLOGIO DA PARETE
WALL CLOCK
Ø 45 x 5,5 cm
dia. 17.75" x 2.25"

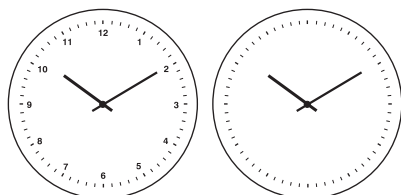

980. ZERO
design Raul Barbieri –
Giorgio Marianelli, 1981
OROLOGIO DA PARETE
WALL CLOCK
Ø 32 x 5 cm
dia. 12.5" x 2"

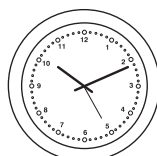



REXITE STORY

■ IN PRODUZIONE / IN PRODUCTION
 ■ FUORI CATALOGO / DISCONTINUED

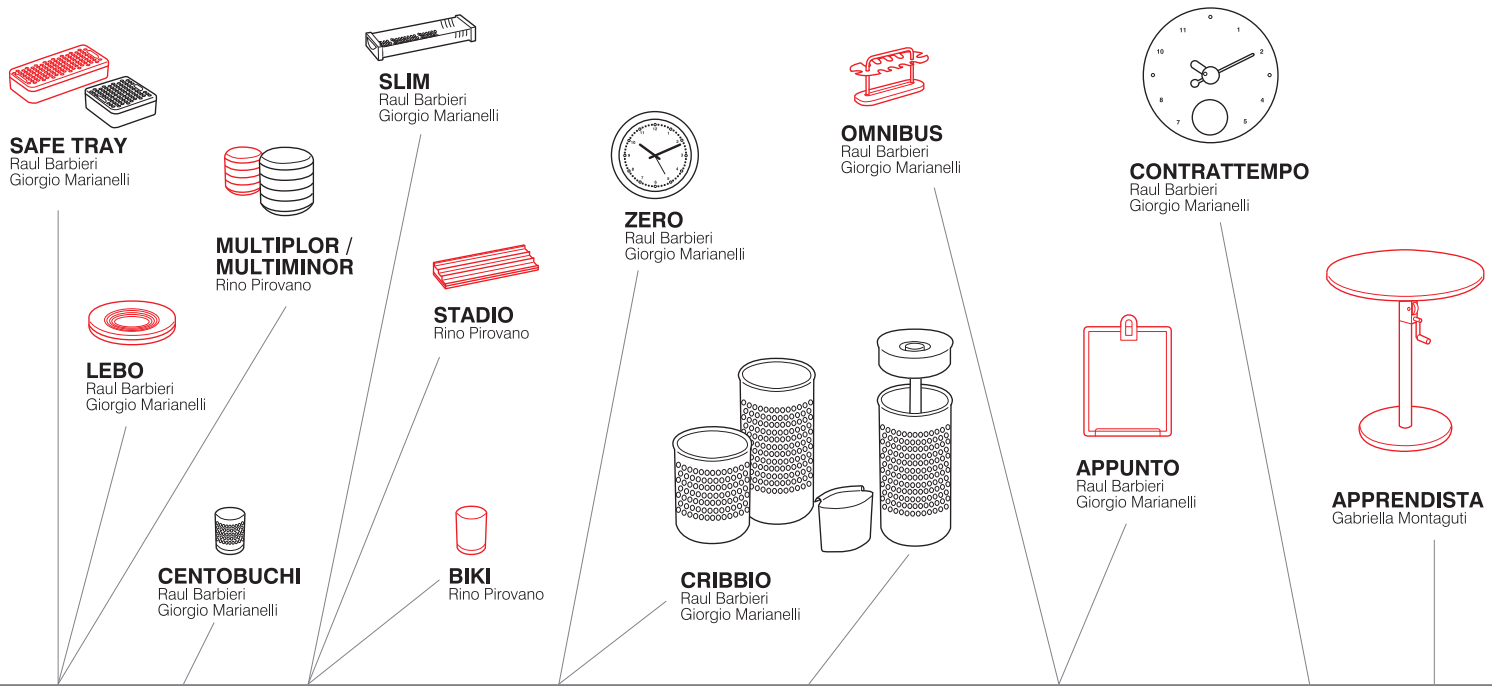

1977 1978 1979 1980 1981 1982 1983 1984 1985 1986 1987 1988

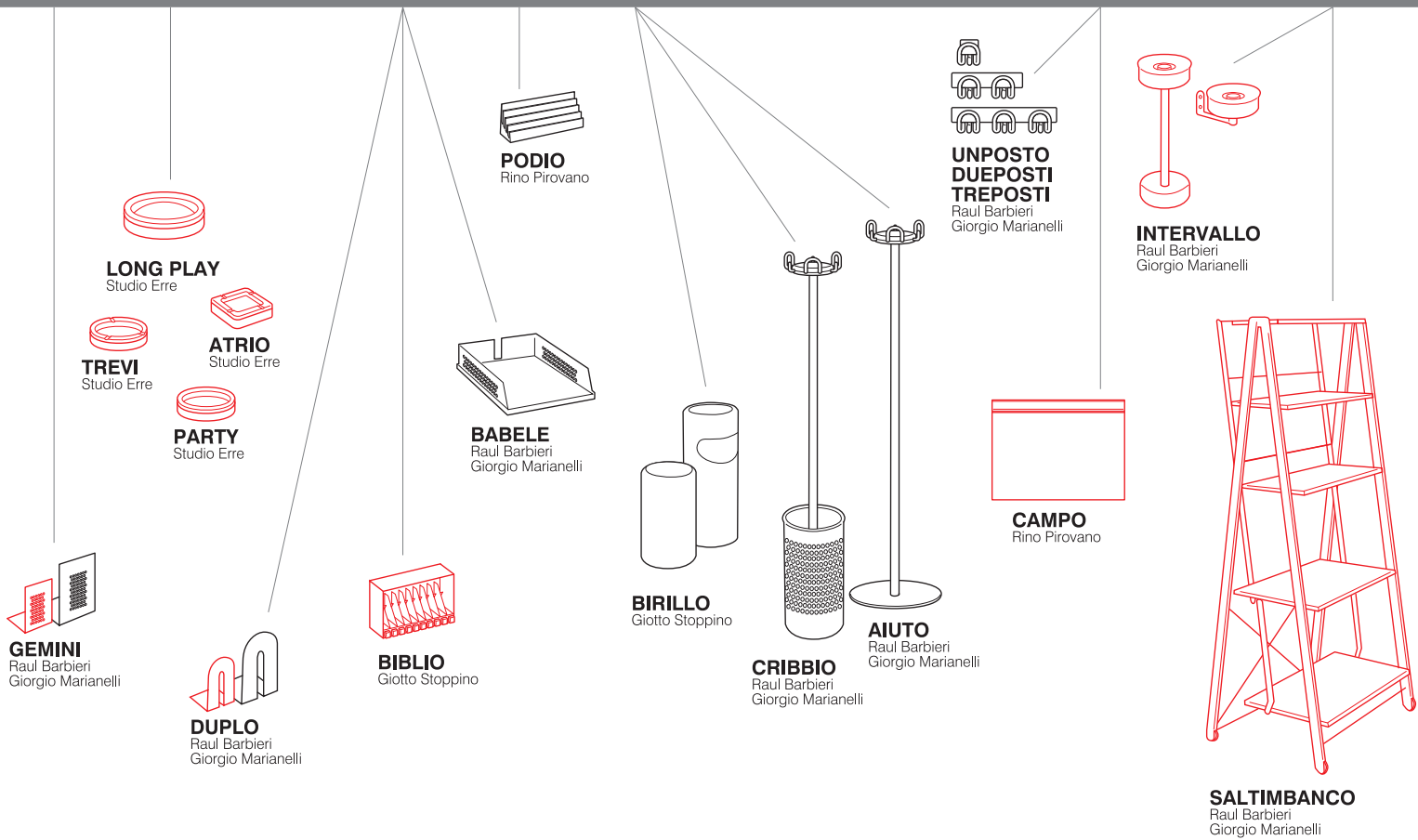

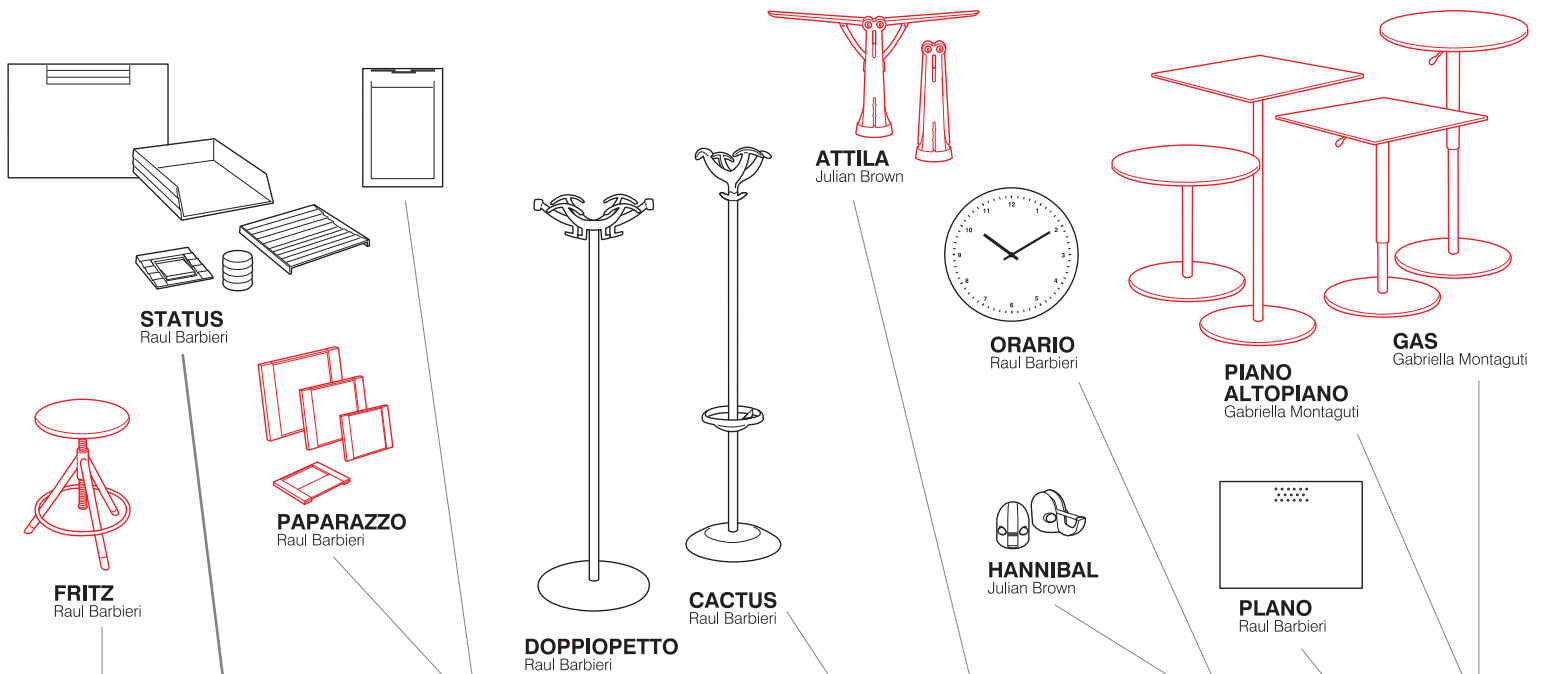

1989 1990 1991 1992 1993 1994 1995 1996 1997 1998 1999 2000

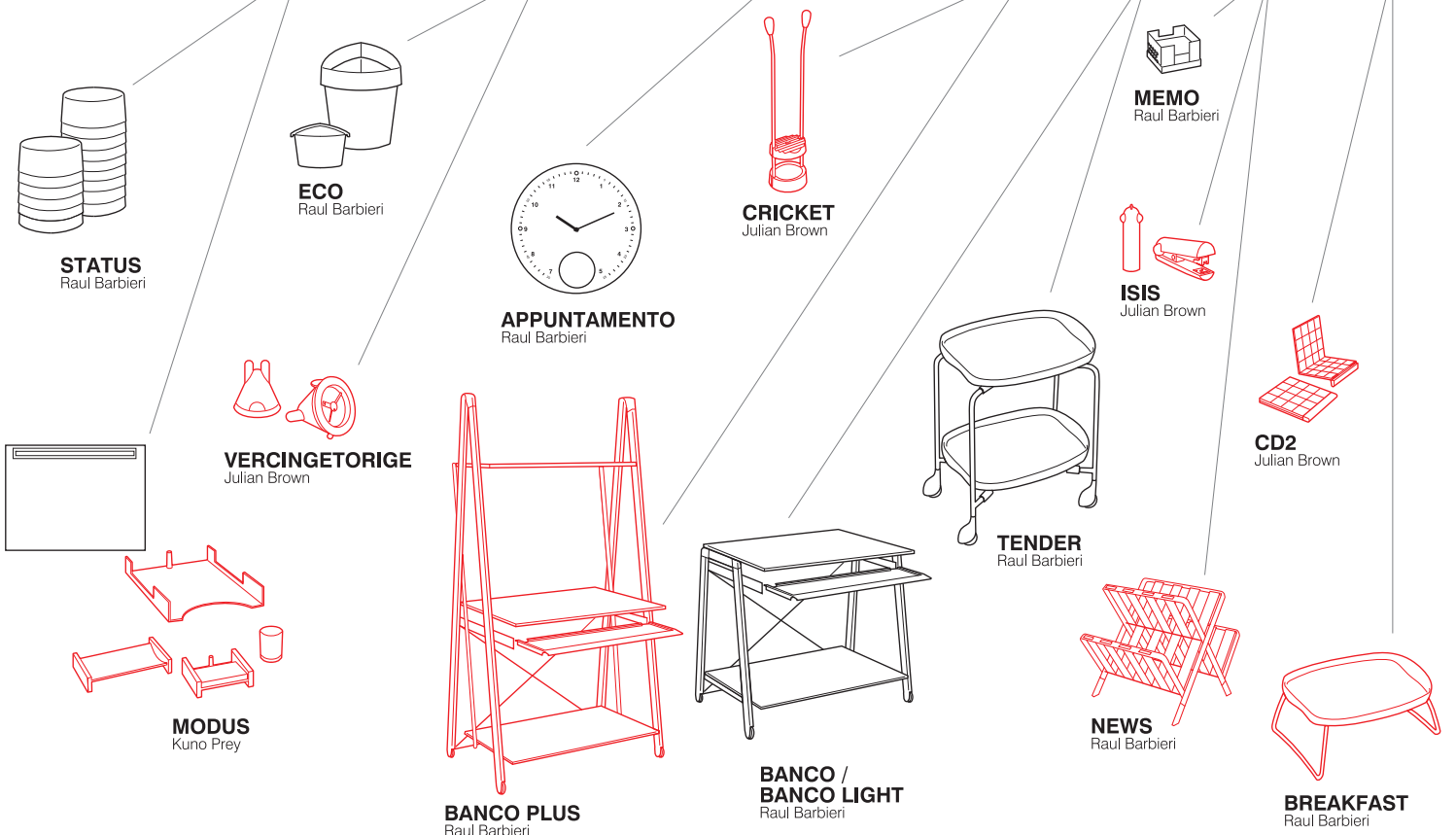

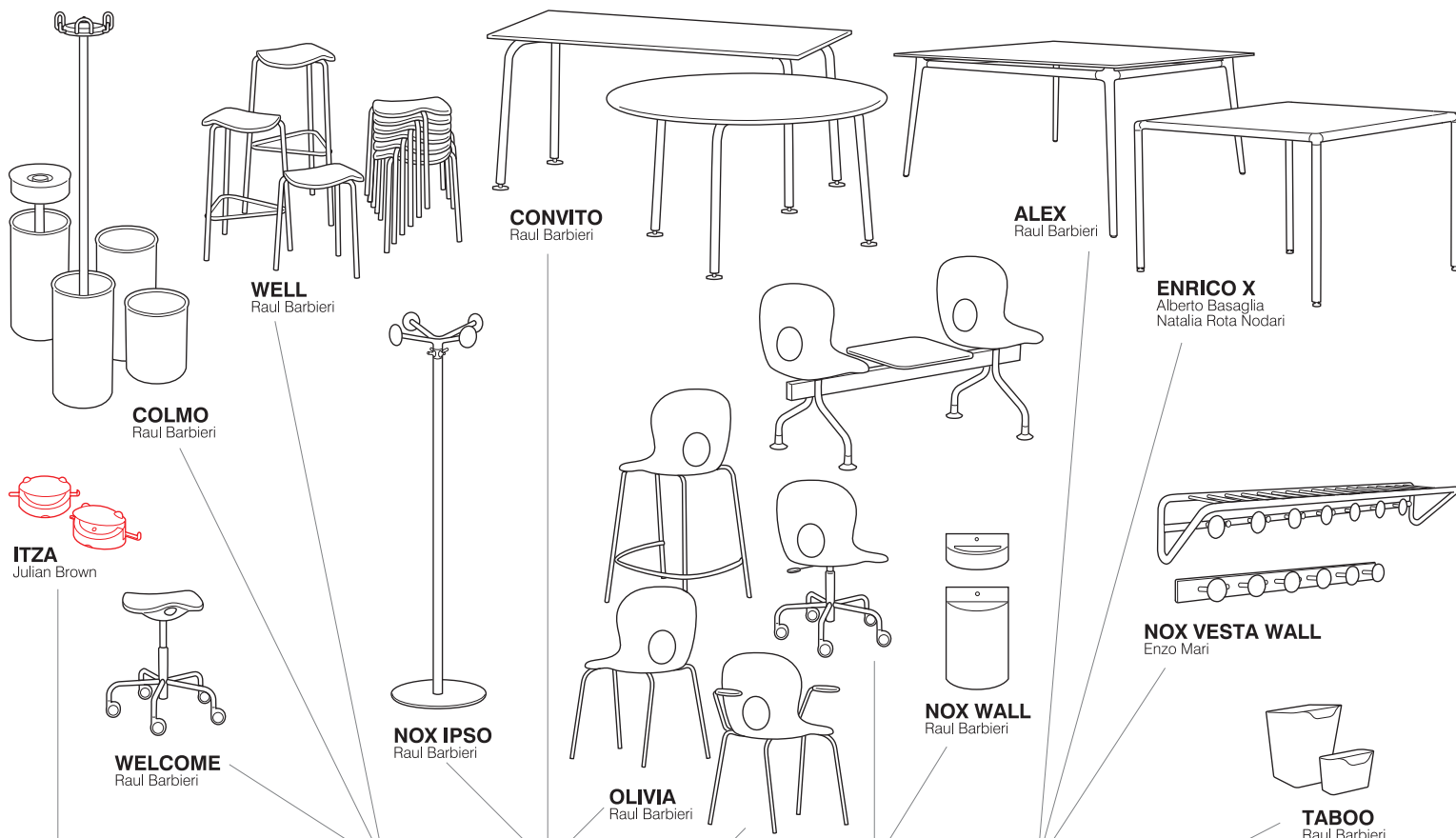

2001 2002 2003 2004 2005 2006 2007 2008 2009

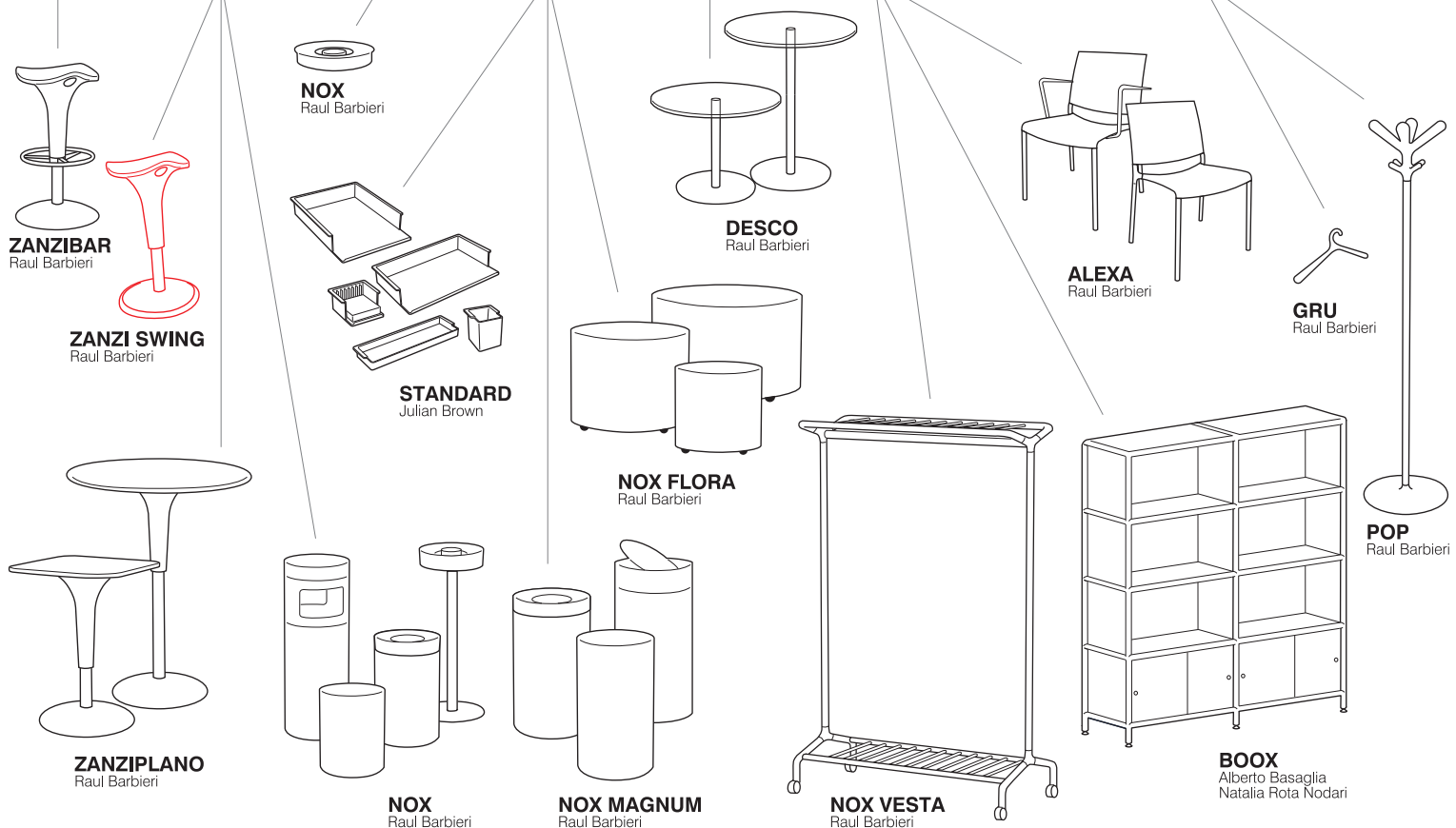

DESIGNER



RAUL BARBIERI

Nato nel 1946 a Milano, si laurea in Architettura presso il Politecnico nel 1972. Durante gli studi universitari collabora con il dipartimento di disegno industriale della Olivetti diretto da Ettore Sottsass e lì conosce Giorgio Marianelli, con cui nel 1974 fonda a Milano lo studio Barbieri e Marianelli Architetti. Nel 1989 apre il proprio studio individuale di architettura sempre a Milano, dove vive e lavora tutt'ora. La sua collaborazione con Rexite inizia nel 1978 e diventa sempre più importante e prolifica, fino a portarlo ad assumere il ruolo di direttore artistico dell'azienda. Coordinatore del dipartimento progettisti ADI per lungo tempo, collabora con numerose aziende italiane ed estere e molti dei suoi progetti ricevono premi nei più importanti concorsi internazionali di design.

Born in 1946 in Milan, he graduated in Architecture from the Polytechnic University in 1972. While at university he collaborated with the industrial design department at Olivetti directed by Ettore Sottsass and there he met Giorgio Marianelli, with whom he founded the Barbieri and Marianelli Architecture firm in Milan in 1974. In 1989 he opened his own independent architecture firm, again in Milan, where he still lives and works. His collaboration with Rexite started in 1978 and grew increasingly important and prolific, until he took on the role of artistic director of the company. Coordinator of the ADI designers department for a long time, he collaborates with numerous Italian and foreign companies and many of his projects have won prizes at prestigious international design competitions.

Né en 1946 à Milan, il est diplômé en Architecture de l'Université Polytechnique en 1972. Pendant son séjour à l'université, il collabore avec le département de design industriel Olivetti dirigé par Ettore Sottsass et il y rencontre Giorgio Marianelli, avec qui il fonde en 1974 à Milan le Bureau d'Architectes Barbieri et Marianelli. En 1989, il a ouvert son propre bureau d'architecte indépendant à Milan, où il vit et travaille toujours. Sa collaboration avec Rexite commence en 1978 et est de plus en plus importante et prolifique, et l'amène à assumer le rôle de directeur artistique de la compagnie. Coordinateur du département des concepteurs ADI pour une longue période, il collabore avec de nombreuses entreprises italiennes et étrangères et plusieurs de ses projets reçoivent des prix aux concours internationaux de design les plus prestigieux.

1946 in Mailand geboren, beendete sein Architekturstudium an der Technischen Hochschule im Jahr 1972. Während seines Studiums arbeitete er für die Abteilung für Industriedesign bei Olivetti unter der Leitung von Ettore Sottsass. Dort lernte er Giorgio Marianelli kennen, mit dem er 1974 in Mailand das Architekturbüro Barbieri und Marianelli gründete. Im Jahr 1989 eröffnete er ebenfalls in Mailand sein unabhängiges Architekturbüro, das er bis heute betreibt. 1978 begann er seine Zusammenarbeit mit Rexite, die im Lauf der Jahre immer wichtiger und fruchtbarer wurde, bis er schließlich die Rolle des künstlerischen Leiters des Unternehmens einnahm. Als langjähriger Koordinator der Designabteilung ADI arbeitet er mit zahlreichen italienischen und ausländischen Firmen zusammen, und viele seiner Projekte haben bei namhaften und wichtigen internationalen Designwettbewerben einen Preis erhalten.

Nacido en 1946 en Milán, se gradúa en Arquitectura en la Universidad Politécnica en 1972. Mientras realiza sus estudios universitarios, colabora con el departamento de diseño industrial de Olivetti dirigido por Ettore Sottsass, y allí conoce a Giorgio Marianelli, con el que funda en Milán en 1974 el estudio de arquitectura Barbieri e Marianelli Architetti. En 1989, abre su propio estudio individual de arquitectura en Milán, donde aún vive y trabaja. Su colaboración con Rexite se inicia en 1978, y se vuelve cada vez más importante y prolífica, hasta el punto de asumir el papel de director artístico de la compañía. Coordinador del departamento de diseñadores ADI durante un largo tiempo, colabora con numerosas empresas italianas y extranjeras, y muchos de sus proyectos reciben premios en los más prestigiosos concursos internacionales de diseño.



GIORGIO MARIANELLI

Nato nel 1939 a Castiglioncello in provincia di Livorno, si laurea in Architettura al Politecnico di Milano, dove si trasferisce nel 1968 per lavorare presso il dipartimento di disegno industriale della Olivetti diretto da Ettore Sottsass. Lì conosce Raul Barbieri, con cui nel 1974 fonda a Milano lo studio Barbieri e Marianelli Architetti. Nel 1990 apre il proprio studio individuale di architettura e disegno industriale, che nel 1995 diventa Marianelli Design. Collabora con alcune tra le aziende più note del design, da Guzzini a Tronconi, da Foppa Pedretti a Zucchetti Rubinerterie, e molti suoi progetti ricevono importanti premi internazionali. Giorgio Marianelli scompare nel 1998.

Born in 1939 in Castiglioncello in the province of Livorno, he graduated in Architecture at the Polytechnic of Milan, where he moved to in 1968 to work at the industrial design department of Olivetti run by Ettore Sottsass. There he met Raul Barbieri, with whom he founded the Barbieri and Marianelli Architecture studio in Milan in 1974. In 1990, he opened his own independent architecture and industrial design studio, which in 1995 became Marianelli Design. He worked with some of the best known design companies, from Guzzini to Tronconi, Foppa Pedretti to Zucchetti Rubinerterie and many of his projects received important international awards. Giorgio Marianelli died in 1998.

Né en 1939 à Castiglioncello, dans la province de Livourne, il est diplômé en Architecture de l'École polytechnique de Milan, où il a déménagé en 1968 pour travailler au département de design industriel Olivetti dirigé par Ettore Sottsass. Il y rencontre Raul Barbieri, avec qui il a fondé en 1974 à Milan le Cabinet d'Architectes Barbieri et Marianelli. En 1990, il a ouvert son propre bureau d'architecte indépendant et de design industriel, qui en 1995 est devenu Marianelli design. Il travaille avec quelques-unes des entreprises de design les plus connues, de Guzzini à Tronconi, de Foppa Pedretti à Zucchetti Rubinerterie et beaucoup de ses projets reçoivent des prix internationaux importants. Giorgio Marianelli disparaît en 1998.

Geboren 1939 in Castiglioncello, in der Provinz Livorno, schloss er sein Architekturstudium an der Technischen Hochschule Mailand ab, wo er 1968 hinzog, um bei Olivetti in der Abteilung für Industriedesign unter der Leitung von Ettore Sottsass zu arbeiten. Dort lernte er Raul Barbieri kennen, mit dem er 1974 in Mailand das Architekturbüro Barbieri und Marianelli gründete. Im Jahr 1990 eröffnete er sein eigenes unabhängiges Büro für Architektur und Industriedesign, das 1995 zur Marianelli Design umfirmiert wurde. Er arbeitete mit einigen der bekanntesten Design-Unternehmen wie Guzzini, Tronconi, Foppa Pedretti und Zucchetti Rubinerterie zusammen und viele seiner Projekte wurden mit wichtigen internationalen Auszeichnungen prämiert. Giorgio Marianelli starb im Jahr 1998.

Nacido en 1939 en Castiglioncello, en provincia de Livorno, se gradúa en Arquitectura en la Universidad Politécnica de Milán, donde se traslada en 1968 para trabajar en el departamento de diseño industrial de Olivetti dirigido por Ettore Sottsass. Allí conoce a Raul Barbieri, con quien funda en Milán en 1974 el estudio de arquitectura Barbieri e Marianelli Architetti. En 1990 abre su propio estudio individual de arquitectura y diseño industrial, que en 1995 se convierte en Marianelli Design. Colabora con algunas de las empresas de diseño más conocidas, pasa por Guzzini, Foppa Pedretti y Zucchetti Rubinerterie, y muchos de sus proyectos reciben importantes premios internacionales. Giorgio Marianelli desaparece en 1998.



JULIAN BROWN

Nato nel 1955 a Northampton, in Inghilterra, si laurea in Industrial Design nel 1978 e inizia la sua carriera presso lo studio David Carter Associates, conseguendo in seguito un Master in Industrial Design al Royal College of Art di Londra. Lavora poi presso lo studio Porsche Design a Zell am See, in Austria, che lascia nel 1986 per fondare con Ross Lovegrove il Lovegrove and Brown Design Studio a Londra. Nel 1990 apre il proprio studio individuale. La sua collaborazione con Rexite dà vita a numerosi oggetti pluripremiati, come l'orologio sveglia Vercingetorige, lo schiaccia lattine Attila, il dispenser di nastro adesivo Hannibal e il set da scrivania Standard. Julian Brown collabora con numerose aziende in Europa e Giappone e attualmente vive e lavora a Bristol, in Inghilterra.

Born in 1955 in Northampton, England, he graduated in Industrial Design in 1978 and began his career at the David Carter Associates firm, later earning a Masters in Industrial Design at the Royal College of Art in London. He then worked at the Porsche Design Studio in Zell am See, Austria, which he left in 1986 to found the Lovegrove and Brown Design Studio in London together with Ross Lovegrove. In 1990 he opened his own independent firm. His collaboration with Rexite has given rise to numerous award-winning objects, such as the Vercingetorige alarm clock, the Attila can crusher, the Hannibal tape dispenser and Standard desk sets. Julian Brown works with several companies in Europe and Japan and currently lives and works in Bristol, England.

Né en 1955 à Northampton, en Angleterre, il est diplômé en design industriel en 1978 et a commencé sa carrière au David Carter Associates, obtenant plus tard une maîtrise en design industriel au Royal College of Art de Londres. Il a ensuite travaillé au studio Porsche Design de Zell am See, Autriche, qu'il a quitté en 1986 pour fonder avec Ross Lovegrove le Studio de Design Lovegrove et Brown à Londres. En 1990, il a ouvert son propre bureau indépendant. Sa collaboration avec Rexite donne lieu à de nombreux objets primés, tels que le réveil Vercingetorige, l'écrase boîtes Attila, le distributeur de bande adhésive Hannibal et le set de bureau Standard. Julian Brown travaille avec plusieurs sociétés en Europe et au Japon et vit et travaille actuellement à Bristol, en Angleterre.

1955 im englischen Northampton geboren, beendete er 1978 sein Studium in Industrial Design und begann seine Karriere im Studio David Carter Associates. In der Folge absolvierte er ein Masterstudium in Industrial Design am Royal College of Art in London. Dann arbeitete er für das Porsche Design Studio in Zell am See. Österreich, bis er schließlich 1986 mit Ross Lovegrove das Lovegrove and Brown Design Studio in London gründete. Im Jahr 1990 eröffnete er sein eigenes unabhängiges Studio. Seine Zusammenarbeit mit Rexite bringt mehrfach preisgekrönte Objekte hervor, wie den Wecker Vercingetorige, den Dosenzerquetscher Attila, den Klebebandspender Hannibal und das Schreibtisch-Set Standard. Julian Brown arbeitet mit verschiedenen Unternehmen in Europa und Japan zusammen und lebt und arbeitet in Bristol.

Nacido en 1955 en Northampton, Inglaterra, se gradúa en Diseño Industrial en 1978 y comienza su carrera en el estudio David Carter Associates, completando más adelante un Máster en Diseño Industrial en el Royal College of Art de Londres. Trabaja luego en el estudio Porsche Design en Zell am See, Austria, que abandona en 1986 para fundar con Ross Lovegrove el Lovegrove and Brown Design Studio en Londres. En 1990 abre su propio estudio individual. Su colaboración con Rexite da lugar a muchos objetos que obtienen numerosos premios, como el reloj de alarma Vercingetorige, el aplasta-latas Attila, el dispensador de cinta adhesiva Hannibal y el juego de escritorio Standard. Julian Brown colabora con numerosas empresas en Europa y Japón y actualmente vive y trabaja en Bristol, Inglaterra.

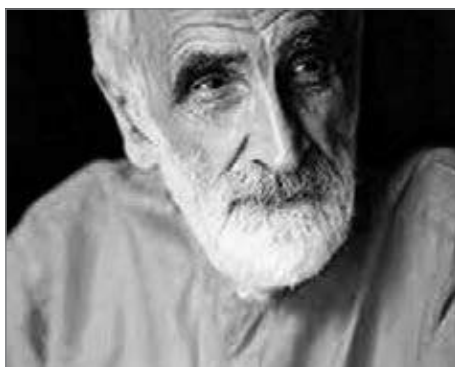

ENZO MARI

Nato nel 1932 a Novara, dopo aver frequentato l'Accademia di Brera a Milano, dal 1957 si dedica attivamente al design industriale. Nell'arco della sua carriera crea per numerose aziende italiane ed estere oltre 1500 progetti, molti dei quali fanno parte delle collezioni di musei di tutto il mondo, tra cui il MoMA di New York, la Galleria Nazionale d'Arte Moderna di Roma e il Triennale Design Museum di Milano. Enzo Mari è presidente ADI dal 1976 al 1979 e consulente della città di Milano per l'arredo urbano dal 1980 al 1984. Nel 2002 il Politecnico di Milano gli conferisce la Laurea Honoris Causa in Disegno Industriale. Vince oltre quaranta premi nazionali e internazionali, tra cui quattro Compasso d'Oro (nel 1979 per la sedia Delfina) e nel 2011 il Compasso d'Oro alla carriera.

Born in 1932 in Novara, after having attended the Academy of Brera in Milan, from 1957 onwards he actively worked in industrial design. Throughout his career, he designed for numerous Italian and foreign companies with over 1,500 projects, many of which are part of museum collections around the world, including the MoMA in New York, the National Gallery of Modern Art in Rome and the Triennale Design Museum in Milan. Enzo Mari was president of ADI from 1976 to 1979, and street furniture consultant to the city of Milan from 1980 to 1984. In 2002, the Polytechnic of Milan awarded him an honorary degree in Industrial Design. He won over forty national and international awards, including four Compasso d'Oro (in 1979 for Delfina chair) and in 2011 the Compasso d'Oro for his career.

Né en 1932 à Novara, après avoir fréquenté l'Académie de Brera à Milan, il se lance activement en 1957 dans la conception industrielle. Tout au long de sa carrière, il crée pour de nombreuses entreprises italiennes et étrangères plus de 1500 projets, dont beaucoup font partie des collections de musées du monde entier, y compris le MoMA à New York, la National Gallery of Modern Art de Rome et de la Triennale design Museum de Milan. Enzo Mari est président de l'ADI de 1976 à 1979 et est consultant de la ville de Milan pour l'aménagement urbain de 1980 à 1984. En 2002, l'École Polytechnique de Milan lui a décerné un Doctorat Honorifique en Design Industriel. Il gagne plus de quarante prix nationaux et internationaux, dont quatre Compasso d'Oro (en 1979 pour la chaise Delfina) et le Compasso d'Oro pour sa carrière en 2011.

Geboren 1932 in Novara, widmet er sich nach seinem Studium an der Accademia di Brera in Mailand ab 1957 dem Industriedesign. Im Lauf seiner Karriere erarbeitet er über 1500 Projekte für italienische und ausländische Unternehmen, von denen seither viele in die Sammlungen von Museen auf der ganzen Welt aufgenommen wurden, darunter das MoMA in New York, die Galleria Nazionale d'Arte Moderna in Rom und das Triennale Design Museum in Mailand. Enzo Mari war von 1976 bis 1979 Vorsitzender der ADI und fungierte von 1980 bis 1984 als städteplanerischer Berater der Stadt Mailand. Im Jahr 2002 erhielt er von der Technischen Hochschule Mailand den Ehrendoktor in Industrial Design. Er erhielt über vierzig nationale und internationale Auszeichnungen, darunter vier Compasso d'Oro (1979 für seinen Delfina-Stuhl) und im Jahr 2011 den Compasso d'Oro für sein Lebenswerk.

Nacido en 1932 en Novara, asiste a la Academia de Brera en Milán, y posteriormente, a partir de 1957, se dedica activamente al diseño industrial. A lo largo de su carrera, crea para numerosas empresas italianas y extranjeras más de 1500 proyectos, muchos de los cuales forman parte de colecciones de museos de todo el mundo, incluyendo el MoMA de Nueva York, la Galería Nacional de Arte Moderno de Roma y la Triennale Design Museum de Milán. Enzo Mari es presidente de ADI de 1976 a 1979 y consejero de la ciudad de Milán para el paisajismo urbano de 1980 a 1984. En 2002, la Universidad Politécnica de Milán le otorga el Doctorado Honoris Causa en Diseño Industrial. Gana más de cuarenta premios nacionales e internacionales, entre ellos cuatro Compasso d'Oro (en 1979 por la silla Delfina) y en 2011 recibe el Compasso d'Oro por toda su trayectoria.



BRUNO MUNARI

Nato nel 1907 a Milano, designer, pittore e autore di numerosi testi dedicati all'educazione infantile, inizia la sua carriera frequentando Marinetti e il movimento Futurista. Nel 1929 apre uno studio con Riccardo Ricas Castagnedi, con cui l'anno successivo realizza la "Macchina Aerea", considerato il primo oggetto in movimento nella storia dell'arte. Nel 1977 crea, presso la Pinacoteca di Brera a Milano, il primo laboratorio per bambini in un museo. Bruno Munari in onore della sua vastissima attività in campo letterario, educativo e artistico, riceve numerosi riconoscimenti, tra cui tre Compasso d'Oro (nel 1979 per il letto multifunzionale Abitacolo) e nel 1995 il Compasso d'Oro alla carriera. Munari firma la sua ultima opera all'età di 90 anni, un anno prima della sua scomparsa nel 1998.

Born in 1907 in Milan, designer, painter and author of several books dedicated to children's education, he began his career by befriending Marinetti and the Futurist movement. In 1929 he opened a firm with Riccardo Ricas Castagnedi, with whom the following year, he produced the "Macchina Aerea" (Aerial Machine), considered the first moving object in art history. In 1977 he established the first workshop for children in a museum at the Pinacoteca di Brera in Milan. In honour of his extensive activities in the field of educational and artistic literature, Bruno Munari received numerous awards, including three Compasso d'Oro (in 1979 for the multifunctional "small house" bed) and in 1995 the Compasso d'Oro for his career. Munari signed his final piece of work at age 90, a year before his death in 1998.

Né en 1907 à Milan, designer, peintre et auteur de plusieurs ouvrages consacrés à l'éducation des enfants, il a commencé sa carrière en fréquentant Marinetti et le mouvement Futuriste. En 1929, il a ouvert un studio avec Riccardo Ricas Castagnedi, avec laquelle l'année suivante il réalise la "Macchina Aerea" (Machine Aérienne), considéré comme le premier objet en mouvement dans l'histoire de l'art. En 1977, il crée, à la Pinacoteca de Brera à Milan, le premier atelier pour les enfants dans un musée. Bruno Munari en l'honneur de ses nombreuses activités dans le domaine de la littérature, de l'éducation et artistique, a reçu de nombreux prix, dont trois Compasso d'Oro (en 1979 pour le lit multifonctionnel Abitacolo) et en 1995, le Compasso d'Oro pour sa carrière. Munari termine son dernier projet à 90 ans, un an avant sa mort en 1998.

Der 1907 in Mailand geborene Designer, Maler und Autor mehrerer Bücher zur frühkindlichen Erziehung begann seine Karriere, indem er sich Marinetti und der Bewegung des Futurismus anschloss. Im Jahr 1929 eröffnete er mit Riccardo Ricas Castagnedi ein Studio, mit dem er im folgenden Jahr die „Macchina Aerea“ (Luftmaschine) realisierte, die als der erste Gegenstand in Bewegung der Kunstgeschichte gilt. Im Jahr 1977 schafft er an der Pinacoteca di Brera in Mailand den ersten Museumsworkshop für Kinder. Bruno Munari erhielt zu Ehren seiner umfangreichen Aktivitäten auf dem Gebiet der Literatur, der Didaktik und Kunst zahlreiche Auszeichnungen, darunter dreimal den Compasso d'Oro (1979 für das Multifunktionsbett Abitacolo) und im Jahr 1995 den Compasso d'Oro für sein Lebenswerk. Im Alter von 90 Jahren beendet Munari sein letztes Werk, ein Jahr vor seinem Tod im Jahr 1998.

Nacido en 1907 en Milán, diseñador, pintor y autor de numerosos textos dedicados a la educación de los niños, comienza su carrera relacionándose con Marinetti y el movimiento futurista. En 1929, abre un estudio con Riccardo Ricas Castagnedi, con el que al año siguiente realiza la "Macchina Aerea" (Máquina Aérea), considerado el primer objeto en movimiento en la historia del arte. En 1977, crea, en la Pinacoteca de Brera, en Milán, el primer taller para niños en un museo. En honor a sus amplias actividades en campo literario, educativo y artístico, Bruno Munari recibe numerosos reconocimientos, entre los cuales tres Compasso d'Oro (en 1979 por la cama multifuncional Abitacolo) y en 1995 recibe el Compasso d'Oro por toda su trayectoria. Munari firma su última obra a los 90 años, un año antes de su muerte en 1998.



GIOTTO STOPPINO

Nato nel 1926 a Vigevano, nel 1953 fonda a Milano con Vittorio Gregotti e Ludovico Meneghetti lo Studio Gregotti, Meneghetti e Stoppino Architetti Associati. Nel 1968 apre il proprio studio individuale, che opera nei settori dell'architettura, dell'arredamento e del design. Presidente dell'ADI dal 1982 al 1984, nel 1983 è anche Presidente del Congresso Internazionale ICSID a Milano. Come designer collabora con le più importanti aziende italiane ed estere del settore, vincendo premi prestigiosi, tra cui due Compasso d'Oro nel 1979 e nel 1991. Durante la sua collaborazione con Rexite realizza Birillo, una famiglia di prodotti comprendente cestini gettacarte, portaombrelli e posacenere da terra, che nel 1984 vince il 17° Premio SMAU Industrial Design. Giotto Stoppino scampare nel 2011.

Born in 1926 in Vigevano, in 1953 he founded the Gregotti, Meneghetti and Stoppino Associate Architecture firm in Milan with Vittorio Gregotti and Ludovico Meneghetti. In 1968 he opened his own independent firm, which operates in the fields of architecture, furniture and design. President of ADI from 1982 to 1984, in 1983 he was also Chairman of the ICSID International Congress in Milan. As a designer, he worked with the most important Italian and foreign companies in the industry, winning prestigious awards, including two Compasso d'Oro in 1979 and 1991. During his collaboration with Rexite he produced Birillo, a collection of products including waste paper baskets, umbrella stands and floor ashtrays which in 1984 won the 17th SMAU Industrial Design Award. Giotto Stoppino passed away in 2011.

Né en 1926 à Vigevano, fonde en 1953 à Milan, avec Vittorio Gregotti et Ludovico Meneghetti, le Bureau d'Architectes Associés Gregotti, Meneghetti et Stoppino. En 1968, il a ouvert sa propre étude indépendante, qui opère dans les domaines de l'architecture, du mobilier et du design. Président de l'ADI de 1982 à 1984, en 1983, il a également été président du Congrès international CIRDI à Milan. En tant que concepteur, il travaille avec les entreprises italiennes et étrangères les plus importantes dans l'industrie, il gagne des prix prestigieux, dont deux Compasso d'Oro en 1979 et 1991. Au cours de sa collaboration avec Rexite, Birillo réalise une famille de produits, comprenant des corbeilles à papier, des porte-parapluies et des cendriers de sol, qui en 1984 a remporté le 17e SMAU Industrial Design Award. Giotto Stoppino disparaît en 2011.

Geboren 1926 in Vigevano, gründete er im Jahr 1953 in Mailand zusammen mit Vittorio Gregotti und Ludovico Meneghetti das Studio Gregotti, Meneghetti e Stoppino Architetti Associati. Im Jahr 1968 eröffnete er sein eigenes, unabhängiges Studio für Architektur, Möbel und Design. Von 1982 bis 1984 war er Vorsitzender des ADI und 1982 auch Vorsitzender des ICSID in Mailand. Als Designer arbeitete er mit den wichtigsten italienischen und ausländischen Unternehmen der Branche zusammen und gewann renommierte Auszeichnungen, darunter zweimal der Compasso d'Oro 1979 und 1991. Während seiner Zusammenarbeit mit Rexite entwirft er Birillo, eine Produktfamilie von Papierkörben, Schirmständer und Ständchenbechern, die 1984 mit dem 17. SMAU Industrial Design Award prämiert wurde. Giotto Stoppino verstarb 2011.

Nacido en 1926 en Vigevano, funda en 1953 en Milán, junto con Vittorio Gregotti y Ludovico Meneghetti, el estudio Gregotti, Meneghetti e Stoppino Architetti Associati. En 1968, abre su propio estudio individual, que opera en los campos de la arquitectura, la decoración y el diseño. Presidente de ADI de 1982 a 1984, en 1983 también es nombrado Presidente del Congreso Internacional del ICSID en Milán. Como diseñador trabaja con las más importantes empresas italianas y extranjeras del sector, y gana prestigiosos premios, incluyendo dos Compasso d'Oro en 1979 y 1991. Durante su colaboración con Rexite realiza Birillo, una familia de productos que incluye papeleras, paragueros y ceniceros de pie, y que en 1984 obtiene el XVII Premio de Diseño Industrial SMAU. Giotto Stoppino desaparece en 2011.



D'URBINO, LOMAZZI

Nati entrambi negli anni '30 a Milano, gli architetti Donato D'Urbino e Paolo Lomazzi iniziano a operare nel 1966 insieme a Jonathan De Pas in campo urbanistico e nella progettazione di architetture, allestimenti e complementi d'arredo. All'attività progettuale affiancano quella teorica attraverso l'impegno con l'ADI, di cui diventano membri del Consiglio direttivo. Nel 1979 vincono il Compasso d'Oro per l'appendiabiti Sciangai. Le loro opere sono presenti nelle collezioni di design di numerosi musei nazionali e internazionali, quali il Triennale Design Museum di Milano, il MoMA di New York, il Victoria & Albert Museum di Londra e il Centre Pompidou di Parigi.

Both born in the '30s in Milan, architects Donato D'Urbino and Paolo Lomazzi began working in 1966 with Jonathan De Pas in the field of urban planning and the design of architecture, outfitting and furnishing accessories. Alongside their design work was their theoretical work with the ADI, of which they became members of the Governing Board. In 1979 they won the Compasso d'Oro for the Sciangai coat hanger. Their works are in the design collections of numerous national and international museums, such as the Triennale Design Museum in Milan, the Museum of Modern Art in New York, the Victoria & Albert Museum in London and the Pompidou Centre in Paris.

Nés dans les années 30 à Milan, les architectes Donato D'Urbino et Paolo Lomazzi commencent à travailler en 1966 avec Jonathan De Pas dans le domaine de l'urbanisme et de l'architecture dans la conception, l'équipement et le mobilier. Activité de conception à côté de celle théorique à travers l'engagement avec la DJA, dont ils deviennent membres du Conseil d'administration. En 1979, ils ont remporté le Compasso d'Oro pour le cintre Sciangai. Leurs œuvres peuvent être trouvées dans les collections de design de nombreux musées nationaux et internationaux, tels que le Triennale Design Museum de Milan, le MoMA à New York, le Victoria & Albert Museum de Londres et le Centre Pompidou à Paris.

Die beide in den 30er Jahren in Mailand geborenen Architekten Donato D'Urbino und Paolo Lomazzi beginnen 1966 ihre Karriere zusammen mit Jonathan De Pas im Bereich der Stadtplanung, Architektur und Inneneinrichtung. An die Seite der praktischen Designentwürfe stellen sie die Theorie im ADI, dessen Verwaltungsrat sie als Mitglieder unterstützen. Im Jahr 1979 gewannen sie für ihren Kleiderbügel Shanghai den Compasso d'Oro. Ihre Werke sind in vielen Design-Sammlungen zahlreicher internationaler Museen wie dem Triennale Design Museum in Mailand, dem MoMA New York, dem Victoria & Albert Museum in London und dem Centre Pompidou Paris vertreten.

Ambos nacidos en los años 30 en Milán, los arquitectos Donato D'Urbino y Paolo Lomazzi comienzan su actividad en 1966 junto con Jonathan De Pas en campo urbanístico y en el desarrollo de complejos arquitectónicos, instalaciones y elementos decorativos. Acompañan su actividad de diseño con actividad teórica a través de su compromiso con la ADI, de la cual se convierten en miembros del Consejo de Administración. En 1979, ganan el Compasso d'Oro por el colgador Sciangai. Sus obras se encuentran en colecciones de diseño de numerosos museos nacionales e internacionales, entre los cuales el Triennale Design Museum de Milán, el MoMA de Nueva York, el Museo Victoria & Albert de Londres y el Centro Pompidou de París.



BASAGLIA, ROTA NODARI

Nati rispettivamente nel 1969 a Varese e nel 1970 Bergamo, si conoscono alla facoltà di Architettura del Politecnico di Milano, dove si laureano con lode nel 1995. Nel 1997 fondano lo studio Basaglia e Rota Nodari Architetti a Brembate (Bergamo). La loro attività professionale è rivolta sia all'architettura che al disegno industriale e alla grafica. La loro collaborazione con Rexite ha inizio nel 2006 con la progettazione del sistema di librerie Boox, premiato l'anno successivo con il Good Design Award e completato in seguito dalla serie di tavoli Enrico X.

Born respectively in 1969 in Varese and Bergamo in 1970, they are well known at the Faculty of Architecture of the Milan Polytechnic, where they graduated with honours in 1995. In 1997, they founded the Basaglia and Rota Nodari Architecture firm in Brembate (Bergamo). Their professional activities have covered architecture, industrial design and graphics. Their collaboration with Rexite began in 2006 with the design of the Boox bookcase system, awarded the following year with the Good Design Award and completed later by the series of Enrico X tables.

Nés respectivement en 1969 à Varese et en 1970 à Bergame, ils se sont rencontrés à la Faculté d'architecture de l'École Polytechnique de Milan, où ils ont obtenu leur diplôme avec mention en 1995. En 1997, ils fondent le studio d'Architectes Basaglia et Rota Nodari à Brembate (Bergame). Leur activité professionnelle est dirigée à la fois vers l'architecture et vers le design industriel et graphique. Leur collaboration avec Rexite commence en 2006 avec la conception des systèmes de bibliothèques Boox, récompensés l'année suivante avec le Good Design Award et complétés plus tard par la série de tables Enrico X.

Die beiden 1969 in Varese und 1970 in Bergamo geborenen Designer lernten sich an der Fakultät für Architektur der Technischen Hochschule Mailand kennen, die sie 1995 mit Auszeichnung abschlossen. 1997 gründeten sie das Studio Basaglia und Rota Nodari Architetti in Brembate (Bergamo). Ihre berufliche Tätigkeit dreht sich sowohl um Architektur, als auch um Industriedesign und Grafik. Ihre Zusammenarbeit mit Rexite beginnt 2006 mit der Gestaltung der Boox-Systembibliothek, die im darauffolgenden Jahr mit dem Good Design Award prämiert und später mit der Produktfamilie der Enrico X-Tische abgeschlossen wurde.

Nacidos respectivamente en 1969 en Varese y en 1970 en Bergamo, se conocen en la Facultad de Arquitectura de la Universidad Politécnica de Milán, donde se gradúan con matrícula de honor en 1995. En 1997, fundan el estudio de arquitectura Basaglia e Rota Nodari Architetti en Brembate (Bergamo). Su actividad profesional se dirige tanto a la arquitectura como al diseño industrial y gráfico. Su colaboración con Rexite comienza en 2006 con el diseño del sistema de librerías Boox, premiado al año siguiente con el Good Design Award y completado posteriormente por la serie de mesas Enrico X.



GABRIELLA MONTAGUTI

Nata a Milano, dove vive e lavora, dopo essersi laureata in Architettura al Politecnico di Milano completa la sua formazione lavorando nello studio dell'architetto Mazzucconi, dove si occupa di progettazione architettonica e di design. Negli anni ottanta inizia l'attività come libera professionista, in un primo tempo occupandosi di design nel settore dei complementi d'arredo e dell'illuminazione, poi fondando l'agenzia di pubblicità Reclame, estendendo così il proprio campo di attività alla pubblicità e alla corporate identity. Per Rexite disegna Apprendista, un tavolino ad altezza regolabile selezionato al 12° Biennial of Industrial Design di Ljubljana nel 1988, i tavolini Piano e Altopiano, e Gas, un tavolino dotato di pistone a gas Menzione d'Oro al XIX Compasso d'Oro.

Born in Milan, where she lives and works, after graduating in Architecture at the Polytechnic in Milan, she completed her education by working in the Mazzucconi firm, where she dealt with architectural planning and design. In the eighties, she began working freelance, as a first step in dealing with the design of furnishings and lighting, then founded the Reclame advertising agency, expanding her area of work to advertising and corporate identity. For Rexite she designed Apprendista, a height adjustable table selected at the 12th Biennial of Industrial Design in Ljubljana in 1988, in addition to Gas, a small table with gas lift, that received an Honorable Mention at the XIX Compasso d'Oro, and the Piano and Altopiano tables.

Née à Milan, où elle vit et travaille, après avoir été diplômée en architecture à l'École Polytechnique de Milan, elle complète sa formation en travaillant dans l'atelier de Mazzucconi, où elle traite de la planification architecturale et de design. Dans les années quatre-vingt, elle a commencé à travailler en tant que freelance, comme une première étape dans le traitement de conception de mobilier et d'éclairage, puis fonde l'agence de publicité Reclame, en étendant son champ d'activité à la publicité et à l'identité d'entreprise. Pour Rexite, elle dessine Apprendista, une table réglable en hauteur sélectionnée à la 12e Biennale de Design Industriel de Ljubljana en 1988, les tables Piano et Altopiano et Gas, une petite table avec piston à gaz qui a reçu la Mention Honorable au XIXème Compasso d'Oro.

In Mailand geboren, arbeitete sie nach dem Abschluss ihrer Ausbildung an der Technischen Hochschule im Architekturstudio Mazzucconi, wo sie mit den Bereichen Architektur und Design befasst war. In den achtziger Jahren beginnt sie ihre Karriere als Freiberuflerin im Bereich Design von Einrichtungsgegenständen und Beleuchtung. Mit der Gründung der Werbeagentur Reclame erweitert Sie ihr Tätigkeitsfeld auf Werbung und Corporate Identity. Für Rexite hat sie Apprendista entworfen, einen in der Höhe verstellbaren Couchtisch, der 1988 auf der 12. Biennale für Industrial Design in Ljubljana prämiert wurde, und Gas, einen Couchtisch mit Gaskolben, der eine lobende Erwähnung vom XIX. Compasso d'Oro erhielt sowie die Couchtische und Piano und Altopiano.

Nacida en Milán, donde vive y trabaja, tras graduarse en Arquitectura en la Universidad Politécnica de Milán completa su formación trabajando en el estudio del arquitecto Mazzucconi, donde se ocupa de la planificación y el diseño arquitectónico. En los años ochenta comienza a trabajar como autónoma. Se ocupa primero de diseño en el sector de elementos decorativos e iluminación, y luego funda la agencia de publicidad Reclame, extendiendo así su campo de actividad a la publicidad y a la identidad corporativa. Para Rexite, diseña Apprendista, una mesa de altura regulable seleccionada en la XII Biennial of Industrial Design de Liubliana en 1988, Gas, una mesita dotada de pistón de gas y premiada con la Mención de Honor en el XIX Compasso d'Oro, y las mesitas Piano y Altopiano.



KUNO PREY

Nato nel 1958 a San Candido, nelle Dolomiti, si diploma in Arte Applicata e inizia a collaborare con il mondo dell'industria, approfondendo le ricerche sui materiali e le nuove tecnologie. Nel 1981 apre uno studio a San Candido e frequenta il Corso Internazionale di Specializzazione in Design a Napoli, dove ha modo di conoscere i maestri Ettore Sottsass e Gaetano Pesce. Completa poi la sua formazione alla Domus Academy di Milano. Trasferitosi a Weimar, in Germania, insegna Product Design alla Bauhaus University di Weimar, continuando la sua attività di designer e realizzando progetti per notissime aziende italiane ed estere, che gli valgono numerosi riconoscimenti a livello internazionale. Dal 2002 è preside della facoltà di Design e Arti della Libera Università di Bolzano.

Born in 1958 in San Candido, in the Dolomites, he graduated in Applied Arts and began working in the industry, carrying out further research into materials and new technologies. In 1981 he opened a studio in San Candido, and he attended the International Course of Specialisation in Design in Naples, where he met the masters, Ettore Sottsass and Gaetano Pesce. He then completed his training at the Domus Academy in Milan. Upon moving to Weimar, Germany, he taught Product Design at the Bauhaus University in Weimar, continuing his work as a designer and creating projects for very well known Italian and foreign companies, which earned him numerous international awards. Since 2002, he has been Dean of the Faculty of Design and Art at the Free University of Bolzano.

Né en 1958 à San Candido, dans les Dolomites, il est diplômé en arts appliqués et a commencé à travailler avec l'industrie, approfondissant la recherche sur les matériaux et les nouvelles technologies. En 1981, il ouvre un studio à San Candido, et il suit le cours international de spécialisation en design à Naples, où il a rencontré les maîtres Ettore Sottsass et Gaetano Pesce. Il a ensuite complété sa formation à l'Académie Domus de Milan. Il a déménagé à Weimar, en Allemagne, où il enseigne le Design Produit à l'Université Bauhaus à Weimar, en continuant son travail en tant que concepteur et en réalisant des projets pour des entreprises italiennes et étrangères très connues, qui lui ont valu de nombreux prix internationaux. Depuis 2002, il est doyen de la Faculté de Design et d'Art de l'Université libre de Bolzano.

1958 in San Candido in den Dolomiten geboren, machte er sein Diplom in angewandter Kunst und begann eine Zusammenarbeit mit der Industrie, wo er seine Studien an Materialien und neuen Technologien weiter vertiefte. Im Jahr 1981 eröffnete er ein Studio in San Candido und nahm am internationalen Kurs zu Spezialisierung des Designs in Neapel teil, wo er Ettore Sottsass und Gaetano Pesce kennen lernte. Er schloss seine Ausbildung an der Domus Academy in Mailand ab. Er zog nach Weimar, wo er an der Bauhaus-Universität als Dozent für Produktdesign lehrte. Seine Arbeit als Designer setzte er fort und realisierte Projekte für sehr bekannte internationale Unternehmen, die ihm zahlreiche internationale Auszeichnungen einbrachten. Seit 2002 ist er Dekan an der Fakultät für Design und Künste an der Freien Universität Bozen.

Nacido en 1958 en San Candido, en las Dolomitas, se graduó en Artes Aplicadas y comienza a colaborar con el mundo de la industria, desarrollando la investigación sobre materiales y nuevas tecnologías. En 1981, abre un estudio en San Candido y asiste al Curso Internacional de Especialización en Diseño en Nápoles, donde conoce a los maestros Ettore Sottsass y Gaetano Pesce. Posteriormente, completa su formación en la Domus Academy de Milán. Habiéndose trasladado a Weimar, Alemania, enseña Diseño de Productos en la Universidad Bauhaus de Weimar, mientras continúa su actividad como diseñador y realiza proyectos para conocidas empresas italianas y extranjeras, lo que le vale numerosos reconocimientos a nivel internacional. Desde 2002, es decano de la Facultad de Diseño y Arte de la Universidad Libre de Bolzano.

AWARDS

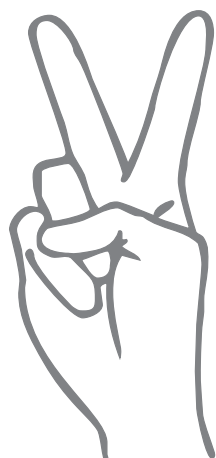

EUROPEAN DESIGN PRIZE
Innovation and design in Europe

PARIS 1997

PRODOTTI A CATALOGO
CURRENT PRODUCTS



ABITACOLO
XI Compasso d'Oro

MILANO 1979

ALEXA
20° Biennial of Industrial Design

LJUBLJANA 2008

APPUNTAMENTO
Form '95

FRANKFURT 1995

BABELE
Workspheres (MoMA)

NEW YORK 2001

BANCO LIGHT
Neocon 2001 (Best of Show)
I.D. Magazine (Honorable Mention)

CHICAGO 2001
NEW YORK 2002

BIRILLO
17° SMAU Industrial Design

MILANO 1984

BOOX
20° Biennial of Industrial Design
The Chicago Athenaeum
Rat für Formgebung

LJUBLJANA 2006
CHICAGO 2007
FRANKFURT 2009

CACTUS
The Chicago Athenaeum

CHICAGO 1997

CONTRATTEMPO
12° Biennial of Industrial Design
Design Plus

LJUBLJANA 1988
FRANKFURT 1988

CONVITO
Interior Innovation
The Chicago Athenaeum

KÖLN 2006
CHICAGO 2006

CRIBBIO
17° SMAU Industrial Design
XVII Premio Nazionale Arti Visive

MILANO 1984
GALLARATE 1993



DELFINA
XI Compasso d'Oro

MILANO 1979

DOPPIOPETTO
ADI Technotel
Neste Forma Finlandia 3
Form '93

GENOVA 1992
ESPOO 1993
FRANKFURT 1993

ECO / ECO PRO
Form '94
ADI Design Index 99

FRANKFURT 1994
MILANO 2000

EVELINE
Tradition / Innovation (Triennale di Milano)

SHANGHAI 2012

HANNIBAL
I.D. Magazine (Best of Category)
Time Magazine (Best of Design 1998)
Design Center Stuttgart
The Chicago Athenaeum
National Stationery Show (Best Product)
Form '99

NEW YORK 1998
NEW YORK 1998
STUTTGART 1998
CHICAGO 1998
NEW YORK 1998
FRANKFURT 1999

NOX

Contract Design GENOVA 2002

NOX MAGNUMArchitektur und Office (Innovationspreis) KÖLN 2004
19° Biennial of Industrial Design LJUBLJANA 2004**OLIVIA**The Chicago Athenaeum CHICAGO 2004
FX International Interior Design (Finalist) LONDON 2004
19° Biennial of Industrial Design LJUBLJANA 2004
Grandesign MILANO 2005
Interior Innovation KÖLN 2005**STATUS**Forum Office Design MILANO 1989
Form '90 FRANKFURT 1990
Forum Office Design MILANO 1991
XVI Compasso d'Oro (Menzione d'Onore) MILANO 1991
Design Plus FRANKFURT 1992
Industrie Forum Design HANNOVER 1992
ADI Technotel GENOVA 1992
XVII Premio Nazionale Arti Visive GALLARATE 1993**TABOO**ADI Design Index 09 MILANO 2010
XXII Compasso d'Oro (Menzione d'Onore) MILANO 2011**TENDER**The Chicago Athenaeum CHICAGO 1999
ADI Design Index 98 MILANO 2000**WELCOME**The Chicago Athenaeum CHICAGO 2003
19° Biennial of Industrial Design LJUBLJANA 2004**WELL**

19° Biennial of Industrial Design LJUBLJANA 2004

ZANZIBARNeocon 2001 (Best of Show) CHICAGO 2001
18° Biennial of Industrial Design LJUBLJANA 2002
Catas 2002 UDINE 2002
FX International Interior Design (Finalist) LONDON 2003
The Chicago Athenaeum CHICAGO 2003**ZANZIPLANO**

I.D. Magazine (Design Distinction) NEW YORK 2003

**PRODOTTI FUORI CATALOGO
DISCONTINUED PRODUCTS****APPRENDISTA**Forum Design MILANO 1987
12° Biennial of Industrial Design LJUBLJANA 1988**ATTILA**BBC Design Awards LONDON 1996
The Chicago Athenaeum CHICAGO 1996
Accent on Design NEW YORK 1997
I.D. Magazine (Design Distinction) NEW YORK 1997
Design Center Stuttgart STUTT GART 1997**BANCO**

The Chicago Athenaeum CHICAGO 1997

BANCO PLUSXVIII Compasso d'Oro (Menzione d'Onore) MILANO 1998
Premio A.M.I. (Miglior Prodotto) LUZERN 1998
Workspheres (MoMA) NEW YORK 2001**BIBLIO**XII Compasso d'Oro (Menzione d'Onore) MILANO 1981
14° SMAU Industrial Design MILANO 1981
10° Biennial of Industrial Design LJUBLJANA 1984**BREAKFAST**Form 2001 FRANKFURT 2001
Design Center Stuttgart STUTT GART 2001**CD2**The Chicago Athenaeum CHICAGO 2000
Form 2001 FRANKFURT 2001
XIX Compasso d'Oro (Menzione d'Onore) MILANO 2001**FRITZ**Design for Europe KORTRIJK 1988
Forum Design MILANO 1989**GAS**

XIX Compasso d'Oro (Menzione d'Onore) MILANO 2001

ISISNational Stationery Show (Best Product) NEW YORK 1999
The Chicago Athenaeum CHICAGO 1999
Form 2000 FRANKFURT 2000
I.D. Magazine (Honorable Mention) NEW YORK 2000**MODUS**Design Plus FRANKFURT 1992
Design Center Stuttgart STUTT GART 1992
Form '92 FRANKFURT 1992**PAPARAZZO**Design Plus FRANKFURT 1993
Neste Forma Finlandia 3 ESPOO 1993**SALTIMBANCO**Forum Design MILANO 1987
Design for Europe KORTRIJK 1988
12° Biennial of Industrial Design LJUBLJANA 1988
Design Plus FRANKFURT 1989
XV Compasso d'Oro (Menzione d'Onore) MILANO 1989**VERCINGETORIGE**Design Plus FRANKFURT 1994
I.D. Magazine NEW YORK 1994
Minerva Design Awards LONDON 1995
International Gift Show TOKYO 1995**ZANZI SWING**Red Dot (Best Selection – Office Design 2003) ESSEN 2003
I.D. Magazine (Design Distinction) NEW YORK 2003
Rat für Formgebung FRANKFURT 2004

REFERENCES

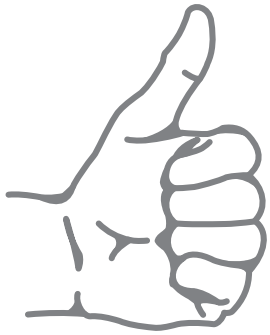

5th Biennial AD – Essen, GERMANY



Vodafone – Sidney, AUSTRALIA



Villa Caprile – Pesaro, ITALY

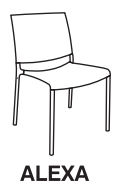

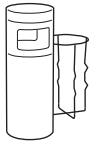

NOX



Fondazione Fiera Milano – Milano, ITALY



OLIVIA



ZANZIPLANO



Junior College Julianadorp – Bergen aan Zee, NEDERLAND



EVELINE



Ristorante Tra la Terra e il Cielo, Moasca (AT), ITALY

ITALY

ABA Bank + Abitare + Agfa Gevaert + Alitalia + Allianz Bank + Arthur Andersen + Assicurazioni Generali + Assolombarda + Audi + Autogrill + AXA Assicurazioni + Banca Agricola Mantovana + Banca d'Italia + Banca di Roma + Banca Fideuram + Banca Indo Suez + Banca Intesa + Banca Nazionale del Lavoro + Banca Popolare di Lodi + Banca Popolare di Milano + Bayer + BLU + BMW + Bonaparte Hotel + Canol + Cisco + Citibank + Coca-Cola + Comando Aeronautica Militare + Commerzbank + Compaq + Coop + Credit Suisse + Credito Emiliano + CRI Croce Rossa Italiana + De Longhi + Deutsche Bank + Digital + e-Biscom + Edisontel + Eptaconsors + Esselunga + Europe Assistance + Ferservizi + FIAT + Fideuram + Fiera Milano + Fila + Fininvest + Forte Hotel Group + Gemeaz Cusin + General Electric + Hotel Ibis + Hyundai + IBM + I.C.E. + Icon Medialab + Illva + Jolly Hotels + Laguna Palace Hotel + Lottomatica + Max Mara + Mediaset + Mediolanum + Mercedes-Benz + MGE UPS System + Ministero della Difesa + Ministero delle Finanze + Mobil Oil + Mondadori + Monte Paschi Siena + Montell + NCR + Nestlé + OVS + Poste Italiane + RAS Bank + RTL + Sanofi Aventis + Siemens + Snai + Sogei + Star Hotels + ST Microelectronics + Technogym + Telecom + Toro Assicurazioni + Trane Italia + Trenitalia + Triennale di Milano + UBS + Una Hotels + Unicredito + Università Bicocca + Università Bocconi + Veneto Banca + Vodafone Omnitel + Volkswagen + Zucchetti Informatica

AUSTRIA

Fachhochschule Steyr + Hypo Bank + Infineon Technologies + Lambergs + Siemens VDO Automotive + Uniqa Tower Versicherungen AG + Vienna Business University

AUSTRALIA

Vodafone

BELGIUM

Cargill Cerestar + Ministerie Van de Vlaamse Gemeenschap + Ministère de la Région Wallone + Parlement Wallone + Supermarché Cactus + UCB

CZECH REPUBLIC

Techo

FRANCE

Accor Hotels + Aquavita + Arthur Andersen + Centre Georges Pompidou + Crédit Agricole + Crédit Lyonnais + Crédit Mutuel + Haworth + Hugo Boss + IBM + Kinnarps + Louis Vuitton + Méridien Hotels + Ministère de la Culture + Ministère des Affaires Etrangères + Novotel + Olivarius Appart'hotel + SFR + Société Générale + Stas Doyer + Steelcase + Yamaha

GERMANY

Accor Hotellerie D + Audi + BMW + Bosch + CC-Bank + Commerzbank + Deimler Chrysler + Deutsche Bank + Deutsche Telekom + Dresdner Bank + Ernst & Young + Eurohypo Bank + EZB European Central Bank + Festo + FUJI Electric Europe + Hypo Bank + Lufthansa + Mc Donald's + Mercedes-AMG + Meridien Hotels + Pricewaterhouse + Red Bull + Reiffeisenbank + SAP Deutschland + Siemens + Telecom Vodafone D2 + Unicredit Bank + Vitra + Volksbank + Volkswagen Bank

IRELAND

A-L Goodboy + Anglo Irish Bank

MEXICO

Telecom

NEDERLAND

Ahrend + Belastingdiensten + ING Bank + Interpolis + Ministerie van Justitie + Philips + Royal Numico + Telecom + UWV

PORTUGAL

Haworth

QATAR

Qatar Foundation

SAUDI ARABIA

King Abdullah Sport City



Vienna Business University – Vienna, AUSTRIA



OLIVIA



150° Anniversario dell'Unità d'Italia – Milano, ITALY



EVELINE



Tipoteca Italiana – Cornuda (TV), ITALY



OLIVIA



ALEXA



EDD Restaurant – Eindhoven, NEDERLAND



OLIVIA



ZANZIPLANO



Antena 3 – Madrid, SPAIN

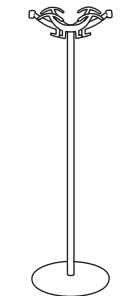

DOPPIOPETTO



Abitare – Milano, ITALY

SCANDINAVIA

AP Møller-Mærsk A/S + Copenhagen Airport + Danske Bank A/S + Deutsche Bank A/S + Erichsson AB + Grundfos A/S + Nokia + Novo Nordisk A/S + Nordea A/S + NNIT A/S + Nykredit A/S + Radisson Hotels + Rambøll A/S + Scandic Hotels + Torm A/S + Vestas A/S + Volvo AB + Wintershall A/S

SPAIN

Antena 3 + El Divino (Ibiza) + Haworth + Mercedes-Benz + Nuevo Hospital de Vigo + Sanitas + Telecom

SWITZERLAND

BMW + Crédit Suisse + Deutsche Bank + Lista + Mercedes-Benz + Mont Blanc + Nestlé + Roche + Schweizer + Rueck + Swiss Re + Telecom

UNITED KINGDOM

Abbey Bank + ABN + AMRO + Bank of Scotland + Cumberland Hotel + Deutsche Bank + Eastpoints Exhibitions + Essex County Council + Fidelity Investments + Invesco Ltd. + Lloyds Bank + Meridien Hotels + Michael Sheridan + Procter & Gamble + Standard Chartered Bank + 100% Design

USA

Arthur Andersen + Austin Library Interiors of Texas + Bell South + BMW + Chicago University + Chicago Children's Hospital + Coca-Cola + Deloitte Touche + Guggenheim Museum N.Y. + Hyundai Kia + Iowa State University + Iowa City Public Library + Seattle Courthouse + MOMA, The Museum of Modern Art, N.Y. + Seattle Polyclinic + Swiss Re + Volkswagen + Wells Fargo

CONCEPT

Raul Barbieri

PROJECT AND LAYOUT

Tobia Barbieri

PHOTOGRAPHY

Armando Rebatto
Francesco Bellesia
Leo Torri
White Studio
Dario Tettamanzi
Gionata Xerra

PRINT

Geca

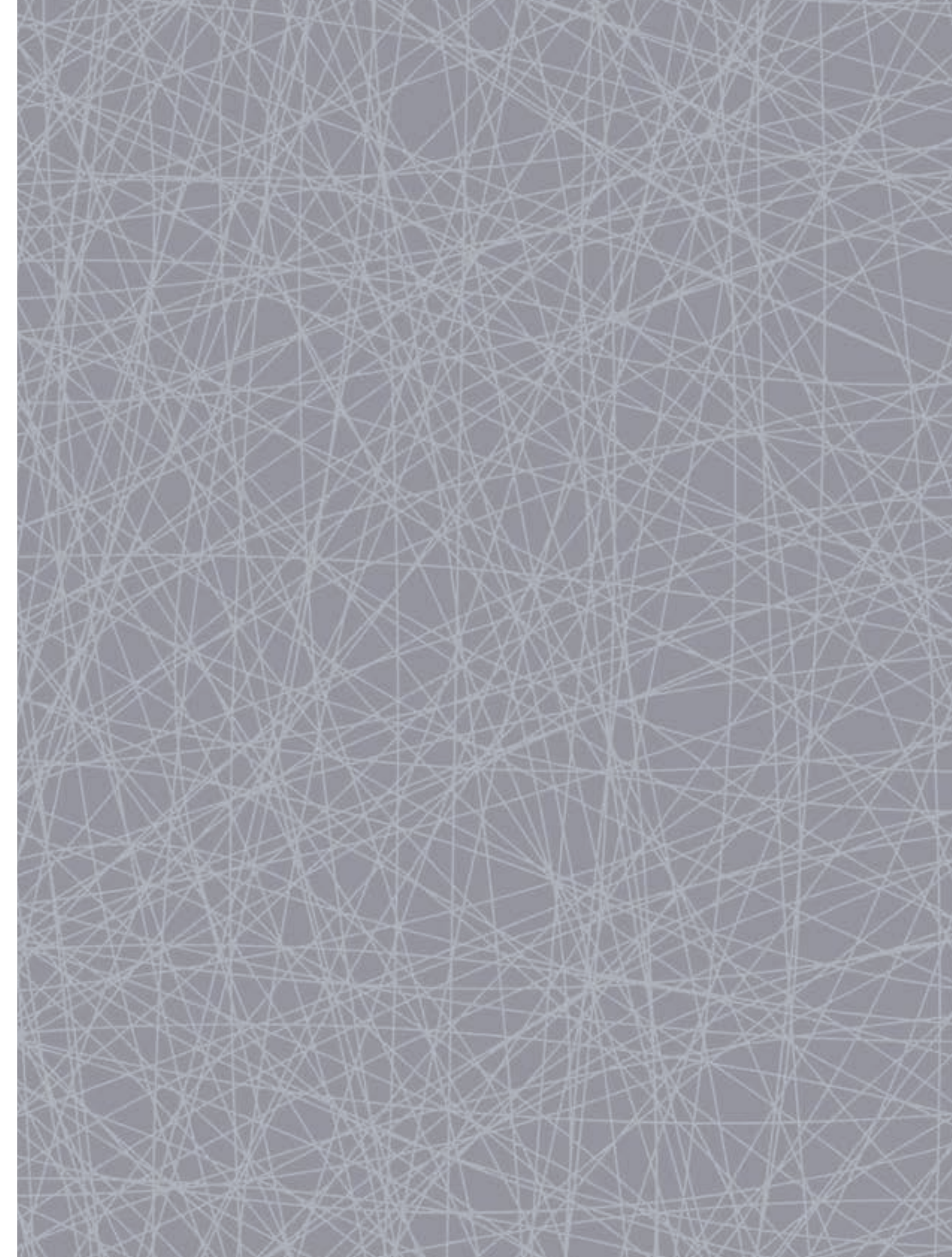

REXITE

“Semplice ma non banale, originale ma non bizzarro”

“Simple yet not ordinary, original but not bizarre”

www.rexite.it

REXITE srl 7, via Edison
I-20090 CUSAGO (Milano) ITALY
e-mail info@rexite.it
telephone +39 02 9039 0013